

# ULS-100

## Universal Level Sensor

Data Sheet No. 262485 Rev. B

---



## Contents

<b>1. About This Document</b>	<b>3</b>	<b>5. Electrical Connection</b>	<b>6</b>
1.1 Function	3	5.1 Safely Connect	6
1.2 Target group	3	5.2 Water Ingress Protection	6
1.3 Document Online Location	3	5.3 Voltage Supply	6
1.4 Symbols Used	3	5.4 Wiring	6
<b>2. Safety</b>	<b>3</b>	<b>6. Maintenance</b>	<b>7</b>
2.1 Authorized Personnel	3	6.1 Basic Maintenance	7
2.2 Appropriate Use	3	6.2 Basic Troubleshooting	7
2.3 Incorrect Use	3	6.3 Returns	8
<b>3. Product Description</b>	<b>3</b>	<b>7. Mechanical Construction</b>	<b>8</b>
3.1 Specifications	4	<b>8. Certificates &amp; Approvals</b>	<b>8</b>
3.2 Part Number Nomenclature	4	8.1 Approvals	8
3.3 Sensor Labels	5	<b>9. Contact Information</b>	<b>8</b>
3.4 Operating Principle	5		
3.5 Sensor Technology	5		
3.6 Accessories	5		
<b>4. Installation</b>	<b>5</b>		
4.1 Mounting	5		
4.2 Orientation	6		
4.3 Installation Examples	6		

## 1. About This Document

### 1.1 Function

This instruction provides the information required for mounting, connection, setup, maintenance, and resolving faults. Please read this information before installing the sensor and putting the instrument into operation and keep this manual accessible. All performance characteristics within this document are at a set of standard conditions, and user experience may differ depending on varying application conditions.

### 1.2 Target group







This operating instruction manual is directed for trained personnel. Only properly trained staff should install and/or repair this product.

### 1.3 Document Online Location

<https://www.gemssensors.com/docs/default-source/resource-files/product-manual/uls-100-data-sheet>



### 1.4 Symbols Used

-  **INFORMATION, NOTE, TIP:**  
This symbol indicates helpful additional information and tips for successful work.
-  **NOTE:**  
This symbol indicates notes to prevent failures, malfunctions, damage to devices or plants.
-  **CAUTION:**  
Non-observance of the information marked with this symbol may result in personal injury.
-  **WARNING:**  
Non-observance of the information marked with this symbol may result in serious or fatal personal injury.
-  **DANGER:**  
Non-observance of the information marked with this symbol results in serious or fatal personal injury.
-  **EX APPLICATIONS:**  
This symbol indicates special instructions for Ex applications.
-  **BATTERY DISPOSAL:**  
This symbol indicates special information about the disposal of batteries and accumulators.

## 2. Safety

### 2.1 Authorized Personnel

All operations described in this document must be carried out by trained, and qualified personnel only. Personal protective equipment must always be worn when working with the sensor.

### 2.2 Appropriate Use

Note the following:



**WARNING: GEMS PRODUCTS MAY ONLY BE USED FOR THE APPLICATIONS DESCRIBED IN THIS DOCUMENT. IF PRODUCTS AND COMPONENTS FROM OTHER MANUFACTURERS ARE USED, THESE MUST BE RECOMMENDED OR APPROVED BY GEMS. PROPER TRANSPORT, STORAGE, INSTALLATION, ASSEMBLY, COMMISSIONING, OPERATION AND MAINTENANCE ARE REQUIRED TO ENSURE THAT THE PRODUCTS OPERATE SAFELY AND WITHOUT ANY PROBLEMS. THE PERMISSIBLE AMBIENT CONDITIONS MUST BE COMPLIED WITH. THE INFORMATION IN THE RELEVANT DOCUMENTATION MUST BE OBSERVED.**

### 2.3 Incorrect Use

Incorrect or inappropriate use of this sensor can increase the likelihood of application hazards not limited to vessel overfill, damage to property, environmental contamination, and damage to the sensor itself.

## 3. Product Description

The Gems' ULS-100 Universal Level Sensor works with a wide variety of media. It eliminates failure caused by moving parts

and works well in high-viscous, high-pressure, humid, and reflective applications. It does not rely on specific gravity or conductivity. It is simplifying product selection, easing maintenance, and reducing inventory with one common sensor type to replace them all.

- Compact design with less-intrusive flush sensing element
- Accurate and repeatable electronic point level switching
- Durable all 316L stainless steel housing with IP6k9k rating
- Wide media range
- Simplified product selection and reduced inventory using one sensor type to replace many different technology options

**Applications**

- Construction
- Water & Wastewater
- Emergency Vehicles
- Power Generation
- Renewable Energy
- Buses & Recreational
- HVAC
- Semiconductor
- Agriculture
- Oil & Water TCUs
- Medical & Laboratory
- General Industrial

**3.1 Specifications**

<b>MEDIA</b>		Aqueous, Oil & Hydrocarbon-Based Liquids, Dielectric > 2.2
<b>MOUNTING</b>		1/2"-14 NPT
<b>WETTED MATERIALS</b>	<b>HOUSING</b>	316L Stainless Steel
	<b>O-RING</b>	Buna-N
	<b>PROBE TIP</b>	PBT/PC Blend
<b>OPERATING PRESSURE</b>		Up to 300 PSIG (20.7 bar)
<b>OPERATING TEMPERATURE</b>		-40° F to +185° F (-40° C to +85° C)
<b>SUPPLY VOLTAGE</b>		9-32 VDC
<b>CURRENT CONSUMPTION</b>		6mA Max. (No Load)
<b>OUTPUT</b>		Sinking or Sourcing Output, 9-32 VDC, 300mA Max.
<b>ELECTRICAL TERMINATION</b>		3-pin Deutsch DT04-3P
<b>INGRESS PROTECTION</b>		IPX7 & IP6k9k Per ISO 20653
<b>APPROVALS</b>		CE 2014/30/EU
<b>VIBRATION</b>		IEC 60068-2-6 (FC) (SINUSOIDAL): 20g Peak
		IEC 60068-2-64 (FH) (RANDOM): 0.1G2/Hz (G Squared Per Hertz)
<b>SHOCK</b>		IEC 60068-2-27 (Ea) 50G, 11ms

Reference Operating Conditions: Ambient Temperature: 20°C (68°F) ±5°C; Media Temperature: 20°C (68°F) ±5°C; Process Pressure: 1 Bar (14.5 PSI); Media Type: Water; Humidity: <60% RH Non-condensing

**3.2 Part Number Nomenclature**

ULS-100		-	X		-	2		-	Y		-	X		-	XX		-	XX	
<b>SERIES</b>	<b>ACTUATION CONDITION</b>		<b>THREAD SIZE</b>		<b>INTEGRAL CONNECTOR</b>		<b>MEDIA BASED SENSING TYPE</b>		<b>TIME DELAY (INCREASING LEVEL)</b>		<b>TIME DELAY (DECREASING LEVEL)</b>								
	A - Wet Sink	2 - 1/2-14 NPT		Y - Deutsch DT04-3P		W - Water	00 - Std. 10ms	00 - Std. 10ms											
	B - Dry Sink					H - Hydrocarbon	03 - 3 sec.	03 - 3 sec.											
	C - Wet Source						05 - 5 sec.	05 - 5 sec.											
	D - Dry Source						10 - 10 sec.	10 - 10 sec.											

### 3.3 Sensor Labels

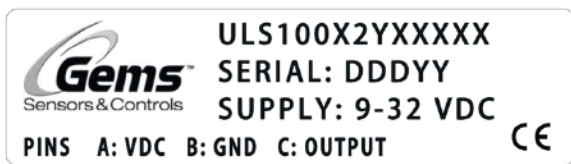

Product Label



Package Label

### 3.4 Operating Principle

The ULS-100 uses a solid-state switching output. It can be configured from our factory to switch to a positive “true” signal in either wet or dry condition. It can also be configured with a built in delay on rising, falling, or both. The output signal switches state at approximately mid-way up the diameter of the sensor face. Diagram example is shown below (signal “true” when wet).

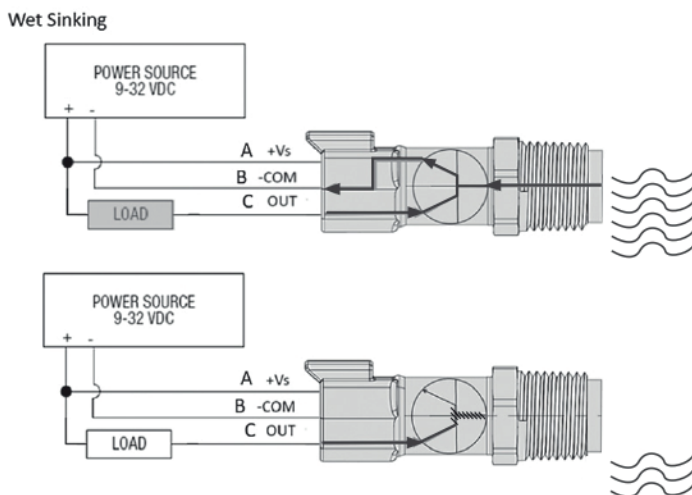

### 3.5 Sensor Technology

The ULS-100 uses capacitive sensing technology to detect the presence or absence of high (water-based) or low (oil-based) dielectric liquid media.

More on Capacitive sensing can be found here: <https://www.gemssensors.com/resource-center/operating-principles-installation-and-maintenance/level/capacitive-level-switch-operating-principle>

### 3.6 Accessories

IP67 rated 3 Pin Deutsch Female mating connector GEMS P/N 248404.

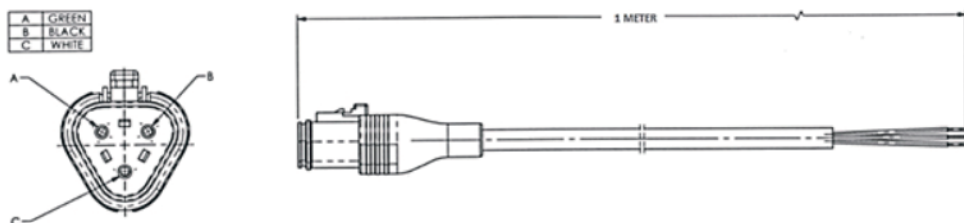

## 4. Installation

### 4.1 Mounting

Using thread sealing tape, tighten sensor 2 turns (maximum) past finger tight. Over torque of the sensor can cause permanent damage. If pipe sealant is used, ensure no sealant is accidentally applied to the sensor element gap. Customer must also ensure pressure seal suitability.



## 4.2 Orientation

Sensor may be mounted in any orientation except vertically in bottom of tank. Customer must review application with special attention to liquid media remaining on flush sensor face when mounted at more severe angles or vertically facing downwards. Optimal performance is with sensor in horizontal position. The sensing element face should be kept at least 0.25" (6.35 mm) away from any surface.

## 4.3 Installation Examples

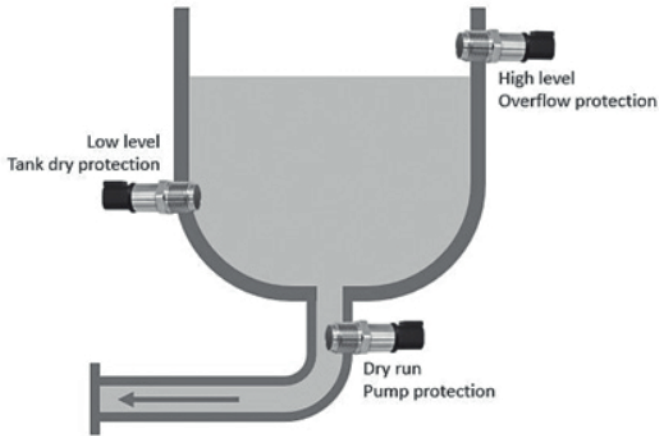

## 5. Electrical Connection

### 5.1 Safely Connect

All electrical connections should be carried out by qualified personnel.



**WARNING: GEMS PRODUCTS MUST BE MAINTAINED AND INSTALLED IN STRICT ACCORDANCE WITH THE NATIONAL ELECTRICAL CODE AND THE APPLICABLE GEMS PRODUCT DATASHEET THAT COVERS INSTALLATION, OPERATION, AND PROPER MAINTENANCE. FAILURE TO OBSERVE THIS INFORMATION MAY RESULT IN SERIOUS INJURY OR DAMAGES. ELECTRICAL CONNECTIONS SHOULD ONLY BE CARRIED OUT BY TRAINED, AUTHORIZED PERSONNEL. IF OVERVOLTAGE SURGES ARE POSSIBLE, PROPER SURGE PROTECTION SHOULD BE INSTALLED.**

### 5.2 Water Ingress Protection



**WARNING: ALTHOUGH THE ULS-100 COMES WITH IP6K9K RATING, THAT DOES NOT INCLUDE THE ELECTRICAL MATING CONNECTION. TO INSURE BETTER PROTECTION FROM MOISTURE INGRESS, PLEASE CONSIDER THE FOLLOWING MEASURES:**

- FIRMLY INSERT THE MATING CABLE UNTIL FULLY SEATED
- PATH THE CONNECTION CABLE OR WIRES DOWNWARDS

### 5.3 Voltage Supply

<b>SUPPLY VOLTAGE</b>	9-32 VDC
<b>CURRENT CONSUMPTION</b>	6mA Max. (No Load)

### 5.4 Wiring

<b>OUTPUT</b>	Sinking or Sourcing Output, 9-32 VDC, 300mA Max.
---------------	--

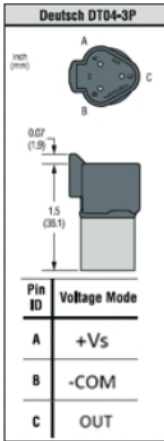

**Wiring Diagram**

**Sinking**

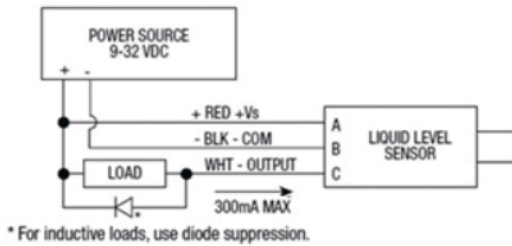

**Sourcing**

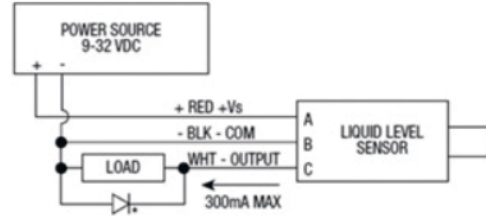

More information on sinking vs sourcing found here:

- <https://www.gemssensors.com/blog/blog-details/sinking-or-sourcing-general-overview>
- <https://www.gemssensors.com/blog/blog-details/how-to-choose-between-wet-sink-or-dry-sink>
- <https://www.gemssensors.com/blog/blog-details/how-to-choose-between-wet-source-or-dry-source>

**6. Maintenance**

**6.1 Basic Maintenance**

Only use cleaning agents that are compatible with the sensor’s materials. Use proper care when cleaning, and only use methods that do not exceed the housing protection rating.

- Electrical entries and mounting points in an enclosed tank may require liquid/vapor sealing.
- Our sensors must not be field-repaired.
- Physical damage sustained by product may render it unserviceable.

**6.2 Basic Troubleshooting**

Is the power supply correct?	<ul style="list-style-type: none"> <li>• Standard sensors require a 9 to 32 VDC input. Use a known good power supply as well as a known good voltmeter and see if the sensor responds to media.</li> </ul>
Is the wiring correct?	<ul style="list-style-type: none"> <li>• Wiring schematics can be found in the instruction bulletin.</li> <li>• The sensing element face should be kept at least 0.1” (2.5mm) away from any surface.</li> </ul>
Did you inspect the sensing element?	<ul style="list-style-type: none"> <li>• Make sure the sensing element is clean without dried-on debris that could cause a false reading, and the face should be kept at least 0.1” (2.5mm) away from any surface.</li> </ul>
Are you trying to detect foam or bubbles?	<ul style="list-style-type: none"> <li>• The ULS-100 was designed to ignore these conditions.</li> </ul>
Have you tested the sensor?	<ul style="list-style-type: none"> <li>• Remove the sensor completely from your mechanical and electrical system. This will isolate any variable in the circuitry. Test with room temp tap water or engine oil. This way, it is a good known target fluid</li> </ul>
Have you reviewed the mounting and switch point location?	<ul style="list-style-type: none"> <li>• The sensor should not be mounted in a port or tube where media can get trapped. It should not be mounted at the top vertically or at a severe angle. Best mounting practice is horizontal direct into tank wall. Liquid level must be at the switch point about half-way up the sensor face.</li> </ul>
Is the dielectric constant outside of the sensor’s range?	<ul style="list-style-type: none"> <li>• Please confirm the dielectric constant of the media.</li> </ul>

Also see our guide on electrical noise here: <https://www.gemssensors.com/blog/blog-details/electrical-noise-various-causes-and-how-to-avoid-effects>

### 6.3 Returns

Standard terms & conditions of sale apply. Refer to the document located online at <https://www.gemssensors.com/docs/default-source/resource-files/terms-conditions/gems-customer-terms>. All RA activity must go through the Gems quality services team. To initiate an RA please go to <https://ecatalog.gemssensors.com/support/ra>

## 7. Mechanical Construction

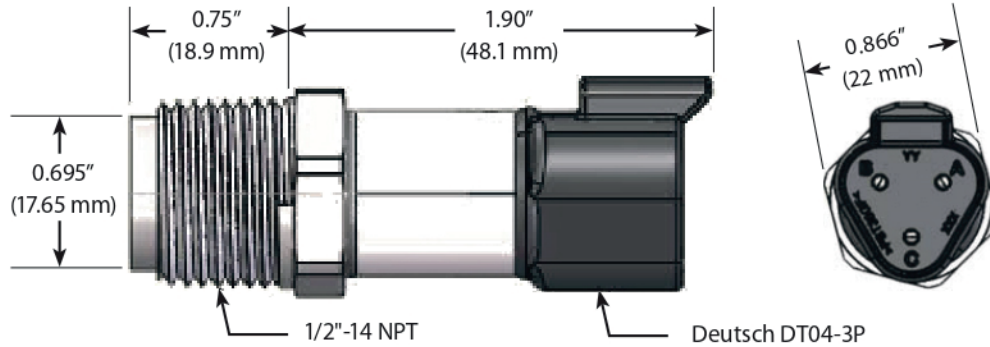

## 8. Certificates & Approvals

### 8.1 Approvals

IPX7 & IP6k9k per ISO 20653  
CE 2014/30/EU

## 9. Contact Information

Toll Free: 1-855-877-9666  
Outside the US: 860-747-3000  
Contact Email: [is@gemssensors.com](mailto:is@gemssensors.com)