

## Flow Measurement

### SITRANS FM (electromagnetic)

#### Flow sensors

#### MAG 3100 and MAG 3100 HT

#### Overview



The SITRANS FM MAG 3100 is an electromagnetic flow sensor in a large variety that meets the demands of almost every flow application.

#### Benefits

- Wide range of sizes: DN 15 to DN 2000 ( $\frac{1}{2}$ " to 78")
- The flexible design is for all applications not covered by the standard industry-specific sensors: MAG 1100, MAG 1100 F, MAG 3100 P and MAG 5100 W
- Wide pressure range: PN 6 to PN 100
- ANSI Class 150/300, AS 2129, AS 4087, JIS K10 and K20. On request up to 690 bar (10 000 psi)
- Wide range of electrode and liner material to fit even the most extreme process media
- Fully welded construction provides a ruggedness that suits the toughest applications and environments.
- Easy commissioning, the SENSORPROM unit automatically updates settings.
- Designed to allow patented SITRANS FM in-situ verification using the SENSORPROM fingerprints.

#### Application

The main applications of the SITRANS FM electromagnetic flow sensors can be found in the following fields:

- Process industry
- Chemical industry
- Steel industry
- Mining
- Utility
- Power generation and distribution
- Oil and gas/HPI
- Water and waste water

#### Design

- Compact or remote mounting possible
- Easy "plug & play" field changeability of transmitter
- ATEX and FM/CSA versions
- High temperature sensor for applications with temperatures up to 180 °C (356 °F)
- Meets EEC directives: PED, 2014/68/EU pressure directive for EN 1092-1 flanges
- Built-in length according to ISO 20456, the standard includes sizes up to DN 400
- Onsite or factory upgrade to IP68/NEMA 6P of a standard sensor.

#### Mode of operation

The flow measuring principle is based on Faraday's law of electromagnetic induction according to which the sensor converts the flow into an electrical voltage proportional to the velocity of the flow.

#### Integration

The complete flowmeter consists of a flow sensor and an associated transmitter MAG 5000, 6000 and 6000 I.

The flexible communication concept USM II simplifies integration and update to a variety of fieldbus systems such as HART, FOUNDATION Fieldbus H1, DeviceNet, PROFIBUS DP and PA, Modbus RTU/RS485.

**Integration** (continued)

**Pressure/temperature curve;**  
**material AISI 316L/1.4404 AS 2129, Class E**

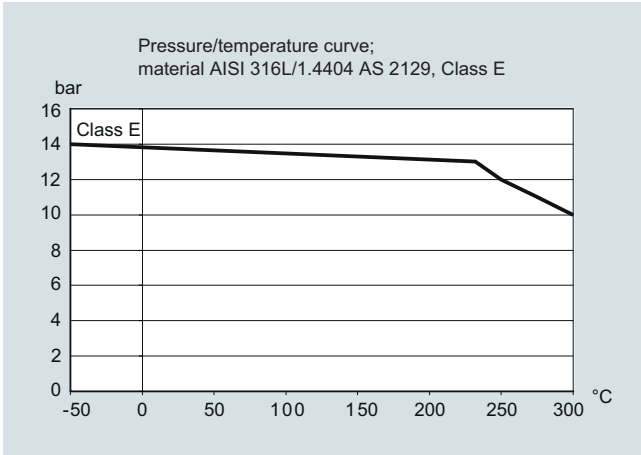

**Pressure/temperature curve to EN (DIN) flanges AISI 304**

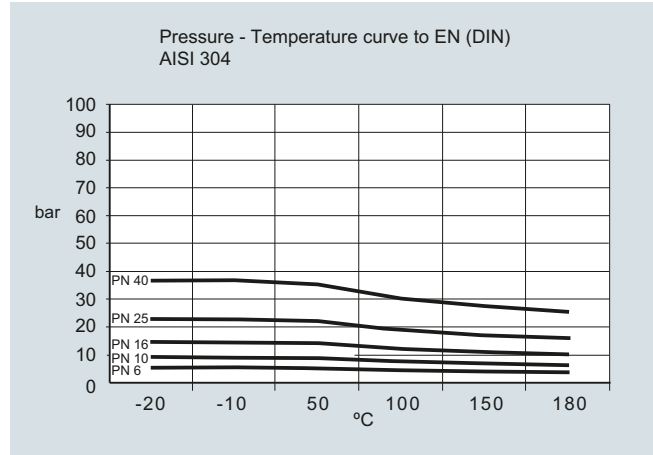

**Pressure/temperature curve - JIS 2200**

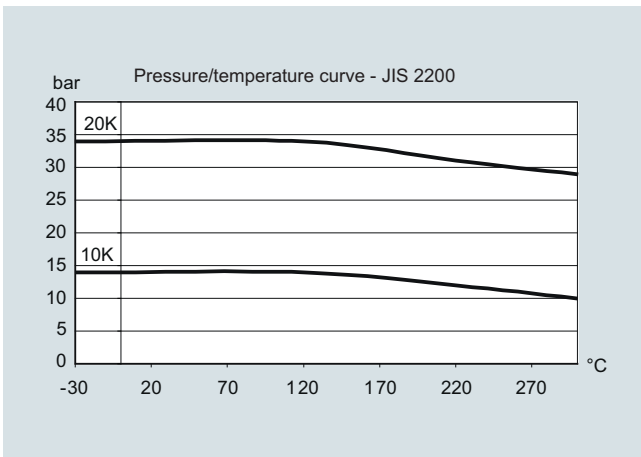

**Pressure/temperature curve to EN (DIN) flanges AISI 316**

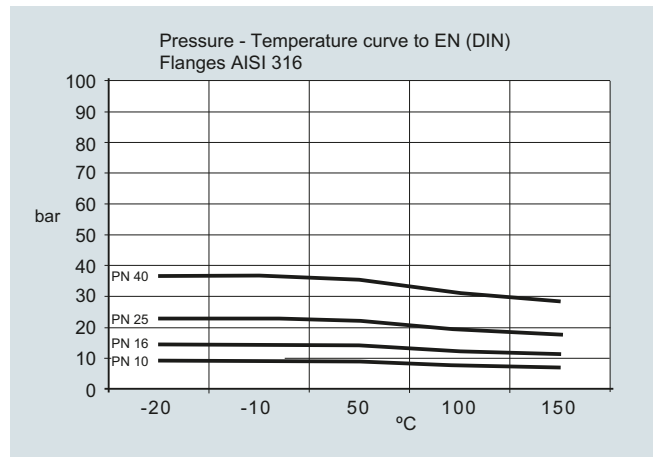

**Pressure/temperature curve to EN (DIN) flanges,**  
**material A 105 carbon steel**

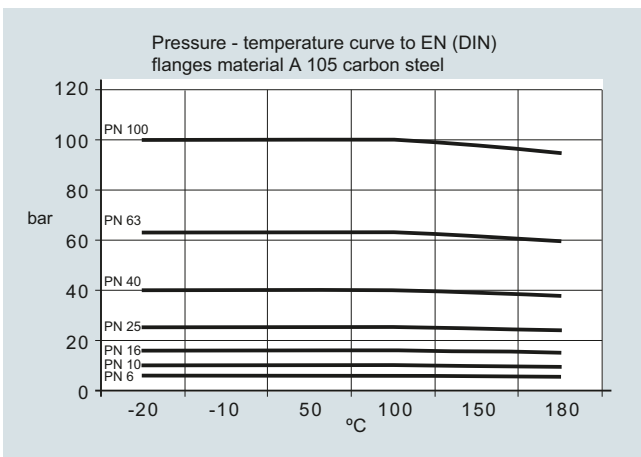

**Pressure/temperature curve to ANSI B16.5 flanges**

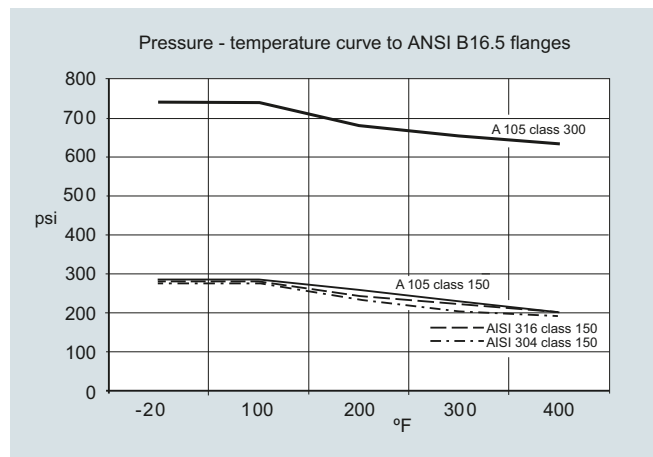

**Note:** The pressure-temperature curves only assist in the selection of a system. No responsibility is taken for the correctness of the information. For further information on PED standard see Pressure Equipment Directive in Appendix (chapter 10).

## Flow Measurement

### SITRANS FM (electromagnetic)

#### Flow sensors

#### MAG 3100 and MAG 3100 HT

#### Technical specifications

Version	MAG 3100	MAG 3100 HT (High Temperature)
Product characteristic	Flexible product program	Flexible product program
Nominal size	DN 15 ... DN 2000 (½" ... 78")	DN 15 ... DN 300 (½" ... 12")
Measuring principle	Electromagnetic induction	Electromagnetic induction
Excitation frequency (Mains supply: 50 Hz/60 Hz)	<ul style="list-style-type: none"> <li>• DN 15 ... 65 (½" ... 2½"): 12.5 Hz/15 Hz</li> <li>• DN 80 ... 150 (3" ... 6"): 6.25 Hz/7.5 Hz</li> <li>• DN 200 ... 1200 (8" ... 48"): 3.125 Hz/3.75 Hz</li> <li>• DN 1400 ... 2000 (54" ... 78"): 1.5625 Hz/1.875 Hz</li> </ul>	<ul style="list-style-type: none"> <li>• DN 15 ... 65 (½" ... 2½"): 12.5 Hz/15 Hz</li> <li>• DN 80 ... 150 (3" ... 6"): 6.25 Hz/7.5 Hz</li> <li>• DN 200 ... 300 (8" ... 12"): 3.125 Hz/3.75 Hz</li> </ul>
<b>Process connection</b>		
Flanges	<p>EN 1092-1, raised face<sup>1)</sup> (EN 1092-1, DIN 2501 &amp; BS 4504 have the same mating dimensions)</p> <ul style="list-style-type: none"> <li>• DN 65 ... 2000 (2½" ... 78"): PN 6 (87 psi)</li> <li>• DN 200 ... 2000 (8" ... 78"): PN 10 (145 psi)</li> <li>• DN 65 ... 2000 (2½" ... 78"): PN 16 (232 psi)</li> <li>• DN 200 ... 600 (8" ... 24"): PN 25 (362 psi)</li> <li>• DN 15 ... 600 (½" ... 24"): PN 40 (580 psi)</li> <li>• DN 50 ... 300 (2" ... 12"): PN 63 (913 psi)</li> <li>• DN 25 ... 300 (1" ... 12"): PN 100 (1450 psi)</li> </ul> <p>ANSI B16.5 (~BS 1560), raised face:</p> <ul style="list-style-type: none"> <li>• ½" ... 24": Class 150 (20 bar (290 psi))</li> <li>• ½" ... 24": Class 300 (50 bar (725 psi))</li> <li>• ½" ... 18": Class 600 (100 bar (1450 psi))</li> </ul> <p>AWWA C-207, flat face 28" ... 78": Class D (10 bar)</p> <p>AS 2129, raised face ½" ... 48": Table E</p> <p>AS 4087, raised face:</p> <ul style="list-style-type: none"> <li>• PN 16 (DN 50 ... 1200, 16 bar (232 psi))</li> <li>• PN 21 (DN 50 ... 600, 21 bar (304 psi))</li> <li>• PN 35 (DN 50 ... 600, 35 bar (508 psi))</li> </ul> <p>JIS B 2220:2004</p> <ul style="list-style-type: none"> <li>• K10 (1" ... 24")</li> <li>• K20 (1" ... 24")</li> </ul> <p>Other flanges and pressure ratings on request</p>	<p>EN 1092-1, raised face (EN 1092-1, DIN 2501 &amp; BS 4504 have the same mating dimensions)</p> <ul style="list-style-type: none"> <li>• DN 15 ... 300 (½" ... 12"): PN 40 (580 psi)</li> <li>• DN 65 ... 300 (2½" ... 12"): PN 16 (232 psi)</li> <li>• DN 200 ... 300 (8" ... 12"): PN 10 (145 psi)</li> <li>• DN 200 ... 300 (8" ... 12"): PN 25 (362 psi)</li> </ul> <p>ANSI B16.5 (~BS 1560), raised face:</p> <ul style="list-style-type: none"> <li>• ½" ... 12": Class 150 (20 bar (290 psi))</li> <li>• ½" ... 12": Class 300 (50 bar (725 psi))</li> </ul> <p>AS 2129, raised face ½" ... 12": Table E</p> <p>Other flanges and pressure ratings on request</p>
<b>Rated operation conditions</b>		
Ambient temperature (conditions also dependent on liner characteristics)		
<ul style="list-style-type: none"> <li>• Standard sensor</li> <li>• Ex sensor</li> </ul>	<p>-40 ... +100 °C (-40 ... +212 °F)</p> <p>-20 ... +60 °C (-4 ... +140 °F)</p>	<p>-40 ... +100 °C (-40 ... +212 °F)</p> <p>For medium temperature up to 150 °C (302 °F): -20 ... +60 °C (-4 ... +140 °F)</p> <p>For medium temperature 150 ... 180 °C (302 ... 356 °F): -20 ... +50 °C (-4 ... +122 °F)</p>
<ul style="list-style-type: none"> <li>• Compact with transmitter</li> <li>- MAG 5000/6000</li> <li>- MAG 6000 I</li> <li>- MAG 6000 I Ex</li> </ul>	<p>-20 ... +60 °C (-4 ... +140 °F)</p> <p>-20 ... +60 °C (-4 ... +140 °F)</p> <p>-20 ... +60 °C (-4 ... +140 °F)</p>	<p>-20 ... +60 °C (-4 ... +140 °F)</p> <p>-20 ... +60 °C (-4 ... +140 °F)</p> <p>-20 ... +60 °C (-4 ... +140 °F)</p>

#### Technical specifications (continued)

Version	MAG 3100	MAG 3100 HT (High Temperature)
<b>Operating pressure</b> [abs. bar] (maximum operating pressure decreases with increasing operating temperature and with stainless steel flanges)	<ul style="list-style-type: none"> <li>• Softrubber 0.01 ... 100 bar (0.15 ... 1450 psi)</li> <li>• EPDM 0.01 ... 40 bar (0.15 ... 580 psi)</li> <li>• Linatex 0.01 ... 40 bar (0.15 ... 580 psi)</li> <li>• Ebonite 0.01 ... 100 bar (0.15 ... 1450 psi)</li> <li>• PTFE               <ul style="list-style-type: none"> <li>- DN ≤ 300 (≤ 12"): 0.3 ... 50 bar (4 ... 725 psi)</li> <li>- 350 ≤ DN ≤ 600 (14" ≤ DN ≤ 24"): 0.3 ... 40 bar (4 ... 580 psi)</li> </ul> </li> <li>• PFA               <ul style="list-style-type: none"> <li>- DN 15 ... 150 (½" ... 6"): Vacuum 0.02 ... 50 bar (0.29 ... 725 psi)</li> </ul> </li> </ul>	<ul style="list-style-type: none"> <li>• PTFE Teflon               <ul style="list-style-type: none"> <li>- DN 15 ... 300 (½" ... 12"): 0.3/0.6 ... 50 bar (4/8 ... 725 psi) (180 °C (356 °F)). Factory mounted grounding rings type E in stainless steel and stainless steel terminal box. Can only be used with remote transmitter.</li> </ul> </li> <li>• PFA               <ul style="list-style-type: none"> <li>- DN 15 ... 150 (½" ... 6"): Vacuum 0.02 ... 50 bar (0.29 ... 725 psi)</li> </ul> </li> </ul>
Enclosure rating	IP67 to EN 60529/NEMA 6P/10, 1 mH <sub>2</sub> O for 30 min Option: IP68 to EN 60529/NEMA 6P,10 mH <sub>2</sub> O cont.	IP67 to EN 60529/NEMA 4X/6, 1 mH <sub>2</sub> O for 30 min Option: IP68 to EN 60529/NEMA 6P,10 mH <sub>2</sub> O cont.
Pressure drop at 3 m/s	As straight pipe	
Test pressure	1.5 x PN (where applicable)	
Mechanical load (vibration)	18 ... 1000 Hz random in x, y, z, directions for 2 hours according to EN 60068-2-36 Sensor: 3.17 g RMS Sensor with compact MAG 5000/6000 mounted transmitter: 3.17 g RMS Sensor with compact MAG 6000 I/6000 I Ex mounted transmitter: 1.14 g RMS	18 ... 1000 Hz random in x, y, z, directions for 2 hours according to EN 60068-2-36 Sensor: 3.17 g RMS Sensor with compact MAG 5000/6000 mounted transmitter: 3.17 g RMS Sensor with compact MAG 6000 I/6000 I Ex mounted transmitter: 1.14 g RMS
Temperature of medium	<ul style="list-style-type: none"> <li>• Soft rubber 0 ... +70 °C (32 ... 158 °F)</li> <li>• EPDM -10 ... +70 °C (14 ... 158 °F)</li> <li>• Linatex (rubber) -40 ... +70 °C (-40 ... +158 °F) (for temperatures below -20 °C (-4 °F) AISI 304 or 316 flanges must be used)</li> <li>• Ebonite 0 ... 95 °C (32 ... 203 °F)</li> <li>• PTFE -20 ... +100 °C (-4 ... +212 °F)</li> <li>• PFA -20 ... +100 °C (-4 ... +212 °F)</li> </ul>	<ul style="list-style-type: none"> <li>• PTFE -20 ... +130 °C (-4 ... +266 °F)</li> <li>• PTFE -20 ... +180 °C (-4 ... +356 °F) Factory mounted grounding rings type E in stainless steel and stainless steel terminal box. Can only be used with remote transmitter.</li> <li>• PFA -20 ... +150 °C (-4 ... +300 °F)</li> </ul>
EMC	2014/30/EU	2014/30/EU
<b>Design</b>		
Weight	See dimensional drawings	
Flange and housing material	Carbon steel ASTM A 105, with corrosion resistant coating of category C4 or C5 according to ISO 12944-2 or Stainless steel AISI 304/1.4301 flanges and carbon steel housing, with corrosion resistant coating of category C4 or C5 according to ISO 12944-2 or Stainless steel AISI 316L/1.4404 flanges and housing, polished	Carbon steel ASTM A 105, with corrosion resistant coating of category C4 according to ISO 12944-2 or Stainless steel AISI 304/1.4301 flanges and carbon steel housing, with corrosion resistant coating of category C4 according to ISO 12944-2 or Stainless steel AISI 316L/1.4404 flanges and housing, polished
Measuring pipe material	Stainless steel AISI 304/1.4301	Stainless steel AISI 304/1.4301
Electrode material	<ul style="list-style-type: none"> <li>• Stainless steel AISI 316Ti/1.4571</li> <li>• Hastelloy C276/2.4819 (PFA: Hastelloy C22/2.4602)</li> <li>• Platinum</li> <li>• Titanium</li> <li>• Tantalum</li> <li>• Ceramic coated stainless steel</li> <li>• Ceramic coated Hastelloy C</li> </ul>	<ul style="list-style-type: none"> <li>• Stainless steel AISI 316Ti/1.4571</li> <li>• Hastelloy C276/2.4819 (PFA: Hastelloy C22/2.4602)</li> <li>• Platinum</li> <li>• Titanium</li> <li>• Tantalum</li> </ul>
Grounding electrode material	<ul style="list-style-type: none"> <li>• Soft rubber, EPDM, Linatex, Ebonite: grounding electrodes built-in by default for stainless steel and Hastelloy C.</li> <li>• PTFE: optional in Stainless steel, Hastelloy C, Titanium, Platinum or Tantalum</li> <li>• PFA: optional in Hastelloy, Tantalum or Platinum</li> <li>• Ceramic coated stainless steel and Hastelloy C276: grounding electrodes built-in by default</li> </ul>	<ul style="list-style-type: none"> <li>• PTFE: no grounding electrodes</li> <li>• PFA: optional in Hastelloy, Tantalum or Platinum</li> </ul>

## Flow Measurement

### SITRANS FM (electromagnetic)

#### Flow sensors

#### MAG 3100 and MAG 3100 HT

#### Technical specifications (continued)

Version	MAG 3100	MAG 3100 HT (High Temperature)
<b>Design (continued)</b>		
Terminal box (remote version only)	<ul style="list-style-type: none"> <li>Standard fibre glass reinforced polyamide</li> <li>Option Stainless steel AISI 316/1.4436</li> <li>Ex Stainless steel AISI 316/1.4436</li> </ul>	<ul style="list-style-type: none"> <li>Standard fibre glass reinforced polyamide (max. 150 °C (302 °F))</li> <li>Stainless steel AISI 316/1.4436</li> <li>Ex Stainless steel AISI 316/1.4436</li> </ul>
Cable entries	<ul style="list-style-type: none"> <li>Remote installation 2 x M20 or 2 x ½" NPT</li> <li>Compact installation</li> <li>MAG 5000/MAG 6000: 4 x M20 or 4 x ½" NPT</li> <li>MAG 6000 I: 2 x M25 or 2 x ½" NPT (for supply/output)</li> <li>MAG 6000 I Ex: 2 x M25 or 2 x ½" NPT (for supply/output)</li> </ul>	<ul style="list-style-type: none"> <li>Remote installation 2 x M20 or 2 x ½" NPT</li> </ul>
<b>Certificates and approvals</b>		
Calibration		
<ul style="list-style-type: none"> <li>Default calibration</li> <li>Special calibration</li> </ul>	Zero-point, 2 x 25 % and 2 x 90 % (default) 5-point calibration: 20%, 40%, 60%, 80%, 100% of factory Q <sub>max</sub> 10-point calibration: ascending and descending at 20%, 40%, 60%, 80%, 100% of factory Q <sub>max</sub> Matched pair calibration: default, 5-point or 10-point	Zero-point, 2 x 25 % and 2 x 90 %
Hazardous areas <sup>2)</sup>		
<ul style="list-style-type: none"> <li>Ex-sensor in compact or remote version with MAG 6000 I Ex</li> </ul>	<ul style="list-style-type: none"> <li>ATEX, FM, CSA, IECEx, EAC Ex, NEPSI               <ul style="list-style-type: none"> <li>- Zone 1 Ex d e ia IIC T6 Gb<sup>4)</sup></li> <li>- Zone 1 Ex e ia IIC T6 Gb<sup>5)</sup></li> </ul> </li> <li>ATEX, FM, CSA, IECEx               <ul style="list-style-type: none"> <li>- Zone 21 Ex tD A21 IP67</li> </ul> </li> <li>FM               <ul style="list-style-type: none"> <li>- XP IS Class I Div. 1 Groups A, B, C, D<sup>6)</sup></li> <li>- DIP Class II+III Div. 1 Groups E, F, G<sup>6)</sup></li> </ul> </li> </ul>	<ul style="list-style-type: none"> <li>ATEX, FM, CSA, IECEx, EAC Ex, NEPSI               <ul style="list-style-type: none"> <li>- Zone 1 Ex d e ia IIC T6 Gb<sup>4)</sup></li> <li>- Zone 1 Ex e ia IIC T6 Gb<sup>5)</sup></li> </ul> </li> <li>ATEX, FM, CSA, IECEx               <ul style="list-style-type: none"> <li>- Zone 21 Ex tD A21 IP67</li> </ul> </li> <li>FM               <ul style="list-style-type: none"> <li>- XP IS Class I Div. 1 Groups A, B, C, D<sup>6)</sup></li> <li>- DIP Class II+III Div. 1 Groups E, F, G<sup>6)</sup></li> </ul> </li> </ul>
<ul style="list-style-type: none"> <li>Standard sensor with/without MAG 5000/6000/6000 I</li> </ul>	<ul style="list-style-type: none"> <li>FM               <ul style="list-style-type: none"> <li>- NI Class I Div. 2 Groups A, B, C, D</li> <li>- NI Class I Zone 2 Groups IIC</li> </ul> </li> </ul>	<ul style="list-style-type: none"> <li>FM               <ul style="list-style-type: none"> <li>- NI Class I Div. 2 Groups A, B, C, D</li> <li>- NI Class I Zone 2 Groups IIC</li> </ul> </li> </ul>
Drinking water	EPDM liner: <ul style="list-style-type: none"> <li>WRAS (WRc, BS690 cold water, GB)</li> <li>NSF/ANSI Standard 617) (Cold water, US)</li> <li>ACS listed (F)</li> <li>DVGW W270 (D)</li> <li>Belgaqua (B)</li> <li>MCERTS (GB) (EPDM or PTFE lining with AISI 316 or Hastelloy electrodes)</li> </ul>	
Pressure equipment	<ul style="list-style-type: none"> <li>PED conforming: All EN1092-1 flanges               <ul style="list-style-type: none"> <li>- 2014/68/EU<sup>3)</sup></li> </ul> </li> <li>CRN</li> </ul>	<ul style="list-style-type: none"> <li>PED conforming: All EN1092-1 flanges               <ul style="list-style-type: none"> <li>- 2014/68/EU<sup>3)</sup></li> </ul> </li> <li>CRN</li> </ul>
Others	<ul style="list-style-type: none"> <li>EAC (Russia, Belarus, Kazakhstan)</li> <li>KCC (South Korea)</li> <li>CMC/CPA (China)</li> </ul>	<ul style="list-style-type: none"> <li>EAC (Russia, Belarus, Kazakhstan)</li> <li>KCC (South Korea)</li> </ul>

Technical specification for transmitter - please see section about transmitters.

<sup>1)</sup> PN 6-40: DN ≤ 600 type 01 (SORF); DN > 600 type 11 (WNRF); PN 63-100: type 11 (WNRF)

<sup>2)</sup> Not for sensors with 300 µm coating.

<sup>3)</sup> For sizes larger than 600 mm (24") in PN 16 PED conformity is available as a cost-added option. The basic unit will carry the LVD (Low Voltage Directive) and EMC approval. All products sold outside of EU and EFTA are excluded from the Pressure Equipment directive, also products sold into certain market sectors are excluded. These include

a) Meters used in networks for the supply, distribution and discharge of water.

b) Meters used in pipelines for the conveyance of any fluid from offshore to onshore.

c) Meters used in the extraction of petroleum or gas, including christmas tree and manifold equipment.

d) Any meter mounted on a ship or mobile offshore platform. For further information on the PED standard and requirements see Pressure Equipment Directive in Appendix (chapter 10).

<sup>4)</sup> In remote version with sensor size DN 15 ... DN 300 (½" ... 12")

<sup>5)</sup> In remote version with sensor size DN 350 ... DN 2000 (14" ... 48")

<sup>6)</sup> In compact version with sensor size DN 15 ... DN 300 (½" ... 12")

<sup>7)</sup> Has to be ordered with the meter. It is not possible to order the certificate afterwards.

## Selection and ordering data

## Article No.

## Article No.

## Sensor SITRANS FM MAG 3100

7ME6310-

Ord.  
code

➤ Click on the Article No. for the online configuration in the PIA Life Cycle Portal.

**Diameter**

DN 15 (½") (PTFE and PFA liner)	1 V
DN 25 (1")	2 D
DN 32 (1¼")	2 H
DN 40 (1½")	2 R
DN 50 (2")	2 Y
DN 65 (2½")	3 F
DN 80 (3")	3 M
DN 100 (4")	3 T
DN 125 (5")	4 B
DN 150 (6")	4 H
DN 200 (8")	4 P
DN 250 (10")	4 V
DN 300 (12")	5 D
DN 350 (14")	5 K
DN 400 (16")	5 R
DN 450 (18")	5 Y
DN 500 (20")	6 F
DN 600 (24")	6 P
DN 700 (28")	6 Y
DN 750 (30") (AWWA and AS 2129 only)	7 D
DN 800 (32")	7 H
DN 900 (36")	7 M
DN 1000 (40")	7 R
DN 1050 (42") (AWWA only)	7 U
DN 1100 (44") (AWWA only)	7 V
DN 1200 (48")	8 B
DN 1400 (54")	8 F
DN 1500 (60")	8 K
DN 1600 (66")	8 P
DN 1800 (72")	8 T
DN 2000 (78")	8 Y

**Flange norm and pressure rating**

<u>EN 1092-1</u>	
PN 6 (DN 65 ... 2000 (2½" ... 78"))	A
PN 10 (DN 200 ... 2000 (8" ... 78"))	B
PN 16 (DN 65 ... 1200 (2½" ... 48"))	C
PN 16, non-PED (DN 700 ... 2000 (28" ... 78"))	D
PN 25 (DN 200 ... 600 (8" ... 24"))	E
PN 40 (DN 15 ... 600 (½" ... 24"))	F
PN 63 (DN 50 ... 300 (2" ... 12"))	G
PN 100 (DN 25 ... 300 (1" ... 12"))	H
<u>ANSI B16.5</u>	
Class 150 (½" ... 24")	J
Class 300 (½" ... 24")	K
Class 600 (½" ... 18")	U
<u>AWWA C-207</u>	
Class D (28" ... 78")	L
<u>AS</u>	
2129, table E	M
4087, PN 16 (DN 50 ... 1200 (2" ... 48")) (Not PTFE and PFA)	N
4087, PN 21 (DN 50 ... 600 (2" ... 24")) (Not PTFE and PFA)	P
4087, PN 35 (DN 50 ... 600 (2" ... 24")) (Not PTFE and PFA)	Q
<u>JIS B 2220:2004</u>	
K10 (1" ... 24")	R
K20 (1" ... 24")	S

## Sensor SITRANS FM MAG 3100

7ME6310-

Ord.  
code**Flange material and coating**

Carbon steel flanges ASTM A 105, corrosion-resistant coating of category C4	1
Stainless steel flanges, AISI 304/1.4301, corrosion-resistant coating of category C4	2
Stainless steel flanges and sensor body, AISI 316L/1.4404, polished	3
Carbon steel flanges ASTM A 105, 300 mm corrosion-resistant coating of category C5	4
Stainless steel flanges, AISI 304/1.4301, 300 mm corrosion-resistant coating of category C5	5

**Liner material**

Soft rubber	1
EPDM	2
PTFE (DN ≤ 300, PN ≤ 50 bar / ≤ 12", PN ≤ 725 psi), PTFE (350 ≤ DN ≤ 600, PN ≤ 40 bar / 14" ≤ DN ≤ 24", PN ≤ 580 psi)	3
Ebonite	4
Linatex (PN ≤ 40 bar (580 psi) DN ≤ 600 (24"))	5
PFA (DN 15 ... 150 (½" ... 6")) (PN ≤ 40 bar (580 psi))	7

**Electrode material**

(Grounding electrodes not for pressure rating PN 100)	
AISI 316Ti/1.4571 (not for PFA)	1
Hastelloy C276/2.4819 (PFA liner: Hastelloy C22/2.4602)	2
Platinum (DN ≤ 300 (12")) (not for Ebonite)	3
Titanium (not for PFA) (DN ≤ 600/24")	4
Tantalum (DN ≤ 600/24") (not for Ebonite)	5
Hastelloy C incl. grounding electrodes (only PFA and PTFE)	6
Platinum incl. grounding electrodes (only PFA and PTFE)	7
Tantalum incl. grounding electrodes (only PFA and PTFE)	8
Ceramic coated stainless steel	9
Ceramic coated Hastelloy C	9
AISI 316Ti incl. grounding electrodes (only PTFE)	9
Titanium incl. grounding electrodes (only PTFE)	9

**Transmitter**

Standard sensor for remote transmitter (order transmitter separately)	A
Ex sensor for remote transmitter (order transmitter separately)	B
MAG 6000 I, Alu. 18 ... 90 V DC, 115 ... 230 V AC	C
MAG 6000 I Alu. 18 ... 30 V DC, Ex	D
MAG 6000 I Alu. 115 ... 230 V, Ex	E
MAG 6000 Polyamide, 11... 30 V DC / 11...24 V AC	H
MAG 6000, Polyamide, 115 ... 230 V AC	J
MAG 5000, Polyamide, 11... 30 V DC / 11...24 V AC	K
MAG 5000, Polyamide, 115 ... 230 V AC	L

**Communication**

No communication, add-on possible	
HART	A
PROFIBUS PA Profile 3 (only MAG 6000/MAG 6000 I)	B
PROFIBUS DP Profile 3 (not for Ex) (only MAG 6000/MAG 6000 I)	F
Modbus RTU/RS 485 (not for Ex) (only MAG 6000/MAG 6000 I)	G
FOUNDATION Fieldbus H1 (only MAG 6000/MAG 6000 I)	E
	J

## Flow Measurement

### SITRANS FM (electromagnetic)

#### Flow sensors

#### MAG 3100 and MAG 3100 HT

#### Selection and ordering data

#### Article No.

Sensor SITRANS FM MAG 3100	7ME6310-	Ord. code
<b>Cable glands/terminal box</b>		
Metric: Polyamide terminal box or MAG 6000 I compact		1
½" NPT: Polyamide terminal box or MAG 6000 I compact		2
Metric: Stainless steel terminal box		3
½" NPT: Stainless terminal box		4

#### Additional information

Please add "-Z" to Article No. and specify Order code(s) and plain text.

#### Order code

#### Certificates

- Pressure test certificate according to EN 10204-3.1 **C01**
- Material certificate according to EN 10204-3.1 **C12**
- Factory certificate according to EN 10204-2.2 **C14**
- Factory certificate according to EN 10204-2.1 **C15**

#### Special calibration

- 5-point calibration for DN 15 ... DN 200<sup>1)</sup> **D01**
- 5-point calibration for DN 250 ... DN 600<sup>1)</sup> **D02**
- 5-point calibration for DN 700 ... DN 1200<sup>1)</sup> **D03**
- 10-point calibration for DN 15 ... DN 200<sup>2)</sup> **D06**
- 10-point calibration for DN 250 ... DN 600<sup>2)</sup> **D07**
- 10-point calibration for DN 700 ... DN 1200<sup>2)</sup> **D08**
- Default (2 × 25 % and 2 × 90 %) match-pair calibration for DN 15 ... DN 200 **D11**
- Default (2 × 25 % and 2 × 90 %) match-pair calibration for DN 250 ... DN 600 **D12**
- Default (2 × 25 % and 2 × 90 %) match-pair calibration for DN 700 ... DN 1200 **D13**
- 5-point, matched-pair calibration for DN 15 ... DN 200<sup>1)</sup> **D15**
- 5-point, matched-pair calibration for DN 250 ... DN 600<sup>1)</sup> **D16**
- 5-point, matched-pair calibration for DN 700 ... DN 1200<sup>1)</sup> **D17**
- 10-point, matched-pair calibration for DN 15 ... DN 200<sup>2)</sup> **D18**
- 10-point, matched-pair calibration for DN 250 ... DN 600<sup>2)</sup> **D19**
- 10-point, matched-pair calibration for DN 700 ... DN 1200<sup>2)</sup> **D20**

#### Terminal blocks

- Factory mounted terminal blocks **N02**

#### Country specific label

- CRN (Canadian Registration Number) **H25**
- Tag name plate, stainless steel (specify in plain text) **Y17**
- Tag name plate, plastic (self adhesive) **Y18**
- Customer-specific transmitter setting **Y20**

#### Factory mounted sensor cables

- Sensor cables wired (specify Article No. for sensor cables and order cables separately) **Y40**
- Sensor cables wired and IP68 sealing (specify Article No. for sensor cables and order cables separately) **Y41**

#### Additional calibrations

- Accredited matched-pair calibration acc. to ISO/IEC 17025: 2005 **On request<sup>3)</sup>**
- Customer-specified calibration up to 10 points **On request<sup>3)</sup>**
- Customer-witnessed calibration **On request<sup>3)</sup>**
- Any of above calibration

<sup>1)</sup> 20 %, 40 %, 60 %, 80 %, 100 % of factory  $Q_{max}$

<sup>2)</sup> Ascending and descending at 20 %, 40 %, 60 %, 80 %, 100 % of factory  $Q_{max}$

<sup>3)</sup> Product Variation Request (PVR)

#### Operating instructions for SITRANS FM MAG 3100

Description	Article No.
• English	<b>A5E03005599</b>
• German	<b>A5E03086288</b>

All literature is available to download for free, in a range of languages, at <http://www.siemens.com/processinstrumentation/documentation>

#### Accessories

Description	Article No.
Potting kit for IP68/NEMA 6P sealing of sensor junction box	<b>FDK-085U0220</b>



Please use online Product selector to get latest updates.

Product selector link:

<http://www.pia-selector.automation.siemens.com>

Selection and ordering data	Article No.	Article No.
<b>Sensor SITRANS FM MAG 3100 HT (High Temperature)</b>	<b>7ME6320-</b>	<b>Sensor SITRANS FM MAG 3100 HT (High Temperature)</b>
<p>➤ Click on the Article No. for the online configuration in the PIA Life Cycle Portal.</p> <p><b>Diameter</b></p> <p>DN 15 (½") 1 V</p> <p>DN 25 (1") 2 D</p> <p>DN 40 (1½") 2 R</p> <p>DN 50 (2") 2 Y</p> <p>DN 65 (2½") 3 F</p> <p>DN 80 (3") 3 M</p> <p>DN 100 (4") 3 T</p> <p>DN 125 (5") 4 B</p> <p>DN 150 (6") 4 H</p> <p>DN 200 (8") 4 P</p> <p>DN 250 (10") 4 V</p> <p>DN 300 (12") 5 D</p> <p><b>Flange norm and pressure rating</b></p> <p>EN 1092-1</p> <p>PN 10 (DN 200 ... 300 (8" ... 12")) B</p> <p>PN 16 (DN 65 ... 300 (2½" ... 12")) C</p> <p>PN 25 (DN 200 ... 300 (8" ... 12")) E</p> <p>PN 40 (DN 15 ... 300 (½" ... 12")) F</p> <p>ANSI B16.5</p> <p>Class 150 (½" ... 12") J</p> <p>Class 300 (½" ... 12") K</p> <p>AS</p> <p>2129, table E M</p> <p><b>Flange material</b></p> <p>Carbon steel flanges ASTM A 105 1</p> <p>Stainless steel flanges, AISI 304/1.4301 2</p> <p>Stainless steel flanges and sensor body, AISI 316L/1.4404, polished 3</p> <p><b>Liner material</b></p> <p>PTFE (150 °C (302 °F)) 2</p> <p>PTFE including type E protection rings 3</p> <p>AISI 316/1.4436 (180 °C (356 °F))</p> <p>PFA (150 °C (302 °F)) (DN 15 ... 150 (½" ... 6")) 7</p> <p><b>Electrode material</b></p> <p>AISI 316Ti/1.4571 (not for PFA) 1</p> <p>Hastelloy C276/2.4819 (PFA liner: Hastelloy C22/2.4602) 2</p> <p>Platinum 3</p> <p>Titanium (not for PFA) 4</p> <p>Tantalum 5</p> <p>Hastelloy C22/2.4602 incl. grounding electrodes (only PFA) 6</p> <p>Platinum incl. grounding electrodes (only PFA) 7</p> <p>Tantalum incl. grounding electrodes (only PFA) 8</p> <p><b>Transmitter</b></p> <p>Standard sensor for remote transmitter (Order transmitter separately) A</p> <p>Ex sensor for remote transmitter (Order transmitter separately) B</p> <p>MAG 6000 I, Alu. 18 ... 90 V DC, 115 ... 230 V AC C</p> <p>MAG 6000 I, Alu. 18 ... 30 V DC, Ex D</p> <p>MAG 6000 I, Alu. 115 ... 230 V AC, Ex E</p> <p>MAG 6000, Polyamide, 11 ... 30 V DC/11 ... 24 V AC H</p> <p>MAG 6000, Polyamide, 115 ... 230 V AC J</p> <p>MAG 5000, Polyamide, 11 ... 30 V DC/11 ... 24 V AC K</p> <p>MAG 5000, Polyamide, 115 ... 230 V AC L</p>		<p><b>Communication</b></p> <p>No communication, add-on possible</p> <p>HART</p> <p>PROFIBUS PA Profile 3 (only MAG 6000/MAG 6000 I) A</p> <p>PROFIBUS DP Profile 3 (only MAG 6000/MAG 6000 I) G</p> <p>Modbus RTU/RS 485 (only MAG 6000/MAG 6000 I) E</p> <p>FOUNDATION Fieldbus H1 (only MAG 6000/MAG 6000 I) J</p> <p><b>Cable glands/terminal box</b></p> <p>Metric: Polyamide terminal box (max. 150 °C (302 °F)) or MAG 6000 I compact 1</p> <p>½" NPT: Polyamide terminal box (max. 150 °C (302 °F)) or MAG 6000 I compact 2</p> <p>Metric: Stainless steel terminal box 3</p> <p>½" NPT: Stainless steel terminal box 4</p> <p><b>Additional information</b></p> <p>Please add "-Z" to Article No. and specify Order code(s) and plain text.</p> <p><b>Certificates</b></p> <ul style="list-style-type: none"> <li>Pressure test certificate according to EN 10204-3.1 C01</li> <li>Material certificate according to EN 10204-3.1 C12</li> <li>Factory certificate according to EN 10204-2.2 C14</li> <li>Factory certificate according to EN 10204-2.1 C15</li> </ul> <p><b>Terminal blocks</b></p> <ul style="list-style-type: none"> <li>Factory mounted terminal blocks N02</li> </ul> <p><b>Country specific label</b></p> <ul style="list-style-type: none"> <li>CRN (Canadian Registration Number) H25</li> </ul> <p>Tag name made, stainless steel (specify in plain text) Y17</p> <p>Tag name plate, plastic (self adhesive) Y18</p> <p>Customer-specific transmitter setting Y20</p> <p><b>Factory mounted sensor cables</b></p> <ul style="list-style-type: none"> <li>Sensor cables wired (specify Article No. for sensor cables and order cables separately) Y40</li> <li>Sensor cables wired and IP68 sealing (specify Article No. for sensor cables and order cables separately) Y41</li> </ul> <p><b>Additional calibrations</b></p> <ul style="list-style-type: none"> <li>Matched-pair calibration On request<sup>1)</sup></li> <li>Accredited matched-pair calibration acc. to ISO/IEC 17025: 2005 On request<sup>1)</sup></li> <li>Customer-specified calibration up to 10 points On request<sup>1)</sup></li> <li>Customer-witnessed calibration On request<sup>1)</sup></li> <li>Any of above calibration</li> </ul> <p><sup>1)</sup> Product Variation Request (PVR).</p>



## Flow Measurement

SITRANS FM (electromagnetic)

Flow sensors

### MAG 3100 and MAG 3100 HT

#### Selection and ordering data

Article No.

#### Accessories for MAG 3100 and MAG 3100 HT sensor

##### Grounding and protection ring - Type C (Stainless steel)<sup>1)</sup>

- Material AISI 304
- For all liners except PTFE and PFA
- 1 pc.

Type C

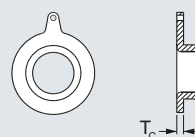

Size DN	Nominal pressure					
	PN 6	PN 10	PN 16	PN 25	PN 40	AS 2129 Table E
	Article No.	Article No.	Article No.	Article No.	Article No.	Article No.
DN 25					FDK:083N8361	FDK:083N8361
DN 40					FDK:083N8362	FDK:083N8362
DN 50					FDK:083N8344	FDK:083N8344
DN 65	FDK:083N8345		FDK:083N8345		FDK:083N8345	FDK:083N8346
DN 80	FDK:083N8347		FDK:083N8347		FDK:083N8347	FDK:083N8347
DN 100	FDK:083N8070		FDK:083N8025		FDK:083N8025	FDK:083N8025
DN 125	FDK:083N8071		FDK:083N8071		FDK:083N8071	FDK:083N8071
DN 150	FDK:083N8072		FDK:083N8008		FDK:083N8073	FDK:083N8008
DN 200	FDK:083N8074	FDK:083N8011	FDK:083N8011	FDK:083N8011	FDK:083N8075	FDK:083N8011
DN 250	FDK:083N8078	FDK:083N8013	FDK:083N8013	FDK:083N8013	FDK:083N8079	FDK:083N8013
DN 300	FDK:083N8080	FDK:083N8012	FDK:083N8012	FDK:083N8081	FDK:083N8082	FDK:083N8012
DN 350	FDK:083N8083	FDK:083N8039	FDK:083N8039	FDK:083N8084	FDK:083N8085	FDK:083N8039
DN 400	FDK:083N8099	FDK:083N8100	FDK:083N8100	FDK:083N8101	FDK:083N8102	FDK:083N8100
DN 450	FDK:083N8103	FDK:083N8103	FDK:083N8104	FDK:083N8104	FDK:083N8105	FDK:083N8104
DN 500	FDK:083N8107	FDK:083N8107	FDK:083N8108	FDK:083N8108	FDK:083N8109	FDK:083N8108
DN 600	FDK:083N8111	FDK:083N8111	FDK:083N8112	FDK:083N8112		FDK:083N8113
DN 700	FDK:083N8300	FDK:083N8294	FDK:083N8294			FDK:083N8372
DN 750						
DN 800	FDK:083N8303	FDK:083N8304	FDK:083N8304			FDK:083N8373
DN 900	FDK:083N8306	FDK:083N8307	FDK:083N8307			FDK:083N8396
DN 1000	FDK:083N8309	FDK:083N8310	FDK:083N8310			FDK:083N8397
DN 1100		FDK:083N8367	FDK:083N8367			FDK:083N8367
DN 1200	FDK:083N8312	FDK:083N8313	FDK:083N8313			FDK:083N8398
DN 1400	FDK:083N8467	FDK:083N8468	FDK:083N8469			
DN 1500	FDK:083N8471	FDK:083N8472	FDK:083N8473			
DN 1600	FDK:083N8475	FDK:083N8476	FDK:083N8477			
DN 1800	FDK:083N8479	FDK:083N8480	FDK:083N8481			
DN 2000	FDK:083N8483	FDK:083N8484	FDK:083N8485			

<sup>1)</sup> Also for MAG 5100 W (7ME6520 > DN 300/12 inch and 7ME6580).

Size Inch	ANSI			
	Class 150	Class 300	JIS K10	JIS K20
	Article No.	Article No.	Article No.	Article No.
1"	FDK:083N8361	FDK:083N8361	FDK:083N8361	FDK:083N8361
1½"	FDK:083N8362	FDK:083N8362	FDK:083N8362	FDK:083N8362
2"	FDK:083N8344	FDK:083N8344	FDK:083N8344	FDK:083N8344
2½"	FDK:083N8345	FDK:083N8345	FDK:083N8345	FDK:083N8345
3"	FDK:083N8347	FDK:083N8347	FDK:083N8347	FDK:083N8347
4"	FDK:083N8025	FDK:083N8025	FDK:083N8070	FDK:083N8025
5"	FDK:083N8071	FDK:083N8071	FDK:083N8071	FDK:083N8071
6"	FDK:083N8008	FDK:083N8073	FDK:083N8008	FDK:083N8008
8"	FDK:083N8011	FDK:083N8076	FDK:083N8011	FDK:083N8011
10"	FDK:083N8013	FDK:083N8079	FDK:083N8013	FDK:083N8079
12"	FDK:083N8012	FDK:083N8082	FDK:083N8012	FDK:083N8081
14"	FDK:083N8039	FDK:083N8085	FDK:083N8083	FDK:083N8039
16"	FDK:083N8100	FDK:083N8102	FDK:083N8100	FDK:083N8101
18"	FDK:083N8104	FDK:083N8106	FDK:083N8103	FDK:083N8104
20"	FDK:083N8107	FDK:083N8110	FDK:083N8107	FDK:083N8108
24"	FDK:083N8113	FDK:083N8114	FDK:083N8111	FDK:083N8112

Size Inch	AWWA C-207
	Article No.
28"	FDK:083N8302
30"	FDK:083N8366
32"	FDK:083N8305
36"	FDK:083N8308
40"	FDK:083N8311
42"	FDK:083N8394
44"	FDK:083N8395
48"	FDK:083N8314
54"	FDK:083N8470
60"	FDK:083N8474
66"	FDK:083N8478
72"	FDK:083N8482
78"	FDK:083N8486

#### Selection and ordering data (continued)

##### Grinding and protection ring - Type E (Stainless steel)

- Material: AISI 316
- For all PTFE liners
- 1 pc. incl. straps and screws

##### Note:

For MAG 3100 HT High temperature version 7ME6320... for PTFE 180 °C (356 °C) versions - grounding ring type E is included and factory mounted.

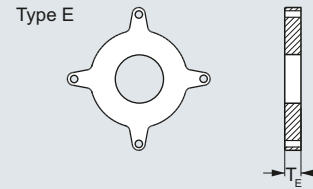

Size DN	Nominal pressure					
	PN 6	PN 10	PN 16	PN 25	PN 40	AS2129, Table E
	Article No.	Article No.	Article No.	Article No.	Article No.	Article No.
DN 15					FDK:083N8365	FDK:083N8365
DN 25					FDK:083N8271	FDK:083N8272
DN 40					FDK:083N8278	FDK:083N8280
DN 50					FDK:083N8282	FDK:083N8281
DN 65	FDK:083N8284		FDK:083N8285		FDK:083N8286	FDK:083N8284
DN 80	FDK:083N8288		FDK:083N8289		FDK:083N8290	FDK:083N8293
DN 100	FDK:083N8116		FDK:083N8117		FDK:083N8118	FDK:083N8117
DN 125	FDK:083N8120		FDK:083N8121		FDK:083N8122	FDK:083N8121
DN 150	FDK:083N8124		FDK:083N8125		FDK:083N8126	FDK:083N8128
DN 200	FDK:083N8129	FDK:083N8130	FDK:083N8130	FDK:083N8131	FDK:083N8132	FDK:083N8134
DN 250	FDK:083N8135	FDK:083N8136	FDK:083N8137	FDK:083N8138	FDK:083N8139	FDK:083N8143
DN 300	FDK:083N8144	FDK:083N8144	FDK:083N8145	FDK:083N8146	FDK:083N8147	FDK:083N8151
DN 350	FDK:083N8152	FDK:083N8153	FDK:083N8154	FDK:083N8155	FDK:083N8156	FDK:083N8153
DN 400	FDK:083N8160	FDK:083N8161	FDK:083N8162	FDK:083N8163	FDK:083N8164	FDK:083N8161
DN 450	FDK:083N8168	FDK:083N8169	FDK:083N8170	FDK:083N8171	FDK:083N8172	FDK:083N8176
DN 500	FDK:083N8177	FDK:083N8178	FDK:083N8179	FDK:083N8180	FDK:083N8181	FDK:083N8185
DN 600	FDK:083N8186	FDK:083N8187	FDK:083N8188	FDK:083N8189		A5E32710253

Size Inch	ANSI			
	Class 150	Class 300	JIS K10	JIS K20
	Article No.	Article No.	Article No.	Article No.
½"	FDK:083N8365	FDK:083N8365		
1"	FDK:083N8272	FDK:083N8272	FDK:083N8271	FDK:083N8271
1½"	FDK:083N8279	FDK:083N8279	FDK:083N8278	FDK:083N8278
2"	FDK:083N8283	FDK:083N8283	FDK:083N8282	FDK:083N8282
2½"	FDK:083N8287	FDK:083N8287	FDK:083N8285	FDK:083N8285
3"	FDK:083N8291	FDK:083N8292	FDK:083N8288	FDK:083N8289
4"	FDK:083N8118	FDK:083N8119	FDK:083N8116	FDK:083N8117
5"	FDK:083N8122	FDK:083N8123	FDK:083N8121	FDK:083N8122
6"	FDK:083N8126	FDK:083N8127	FDK:083N8125	FDK:083N8126
8"	FDK:083N8370	FDK:083N8133	FDK:083N8130	FDK:083N8370
10"	FDK:083N8140	FDK:083N8141	FDK:083N8137	FDK:083N8139
12"	FDK:083N8148	FDK:083N8149	FDK:083N8144	FDK:083N8146
14"	FDK:083N8157	FDK:083N8158	FDK:083N8152	FDK:083N8154
16"	FDK:083N8165	FDK:083N8166	FDK:083N8160	FDK:083N8165
18"	FDK:083N8173	FDK:083N8174	FDK:083N8169	FDK:083N8171
20"	FDK:083N8182	FDK:083N8183	FDK:083N8178	FDK:083N8180
24"	FDK:083N8190	FDK:083N8191	A5E32709738	A5E32710253

##### Note:

For use as protection ring order 2 pcs.  
For use as grounding ring order 1 pc.

**Flow Measurement**

SITRANS FM (electromagnetic)

Flow sensors

**MAG 3100 and MAG 3100 HT****Selection and ordering data****Article No.****Grounding and protecting ring - Type E (Hastelloy)<sup>1)</sup>**

- Material: Hastelloy C276
- For all PTFE liners
- 1 pc. incl. straps and screws

Type E

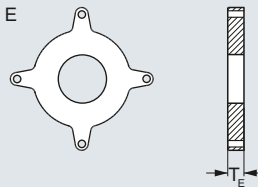

Size DN	Nominal pressure			Size Inch	ANSI	
	PN 6 Article No.	PN 16 Article No.	PN 40 Article No.		Class 150 Article No.	Class 300 Article No.
DN 15			FDK:083N8487	½"	FDK:083N8487	FDK:083N8487
DN 25			FDK:083N8488	1"	FDK:083N8489	FDK:083N8489
DN 40			FDK:083N8490	1½"	FDK:083N8491	FDK:083N8491
DN 50			FDK:083N8492	2"	FDK:083N8493	FDK:083N8493
DN 65	FDK:083N8494	FDK:083N8495	FDK:083N8496	2½"	FDK:083N8497	FDK:083N8497
DN 80	FDK:083N8498	FDK:083N8499	FDK:083N8500	3"	FDK:083N8501	FDK:083N8502
DN 100	FDK:083N8503	FDK:083N8504	FDK:083N8505	4"	FDK:083N8506	FDK:083N8507

<sup>1)</sup> Also for MAG 5100 W (7ME6580).

**Grounding ring - Type Flat ring (Stainless steel)**

- Material: AISI 316
- For all liners (PTFE max. 150 °C (302 °F))
- 1 pc. incl. straps and screws

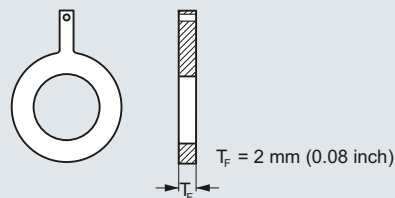

Size DN	Nominal pressure			Size Inch	ANSI	
	PN 10 Article No.	PN 16 Article No.	PN 40 Article No.		Class 150 Article No.	Class 300 Article No.
DN 15			A5E01191968	½"	A5E01191969	
DN 25			A5E01150880	1"	A5E01150022	A5E01150378
DN 40			A5E01191952	1½"	A5E01191961	
DN 50		A5E01192006	A5E01150918	2"	A5E01151121	A5E01151194
DN 65		A5E01191940	A5E01191954	2½"	A5E01191962	
DN 80		A5E01152876	A5E01152876	3"	A5E01152910	A5E01153422
DN 100		A5E01158875	A5E01159072	4"	A5E01159146	A5E01159628
DN 125		A5E01191941	A5E01191956	5"	A5E01191963	
DN 150		A5E01191943	A5E01191957	6"	A5E01191964	
DN 200	A5E01191951	A5E01191944	A5E01191958	8"	A5E01191965	
DN 250	A5E01191950	A5E01191946	A5E01191959	10"	A5E01191966	
DN 300	A5E01191949	A5E01191947	A5E01191960	12"	A5E01191967	

**Selection and ordering data** (continued)**Grounding ring - Type Flat ring (Hastelloy)**

- Material: Hastelloy C276
- For all liners (PTFE max. 150 °C (302 °F))
- 1 pc. incl. straps and screws

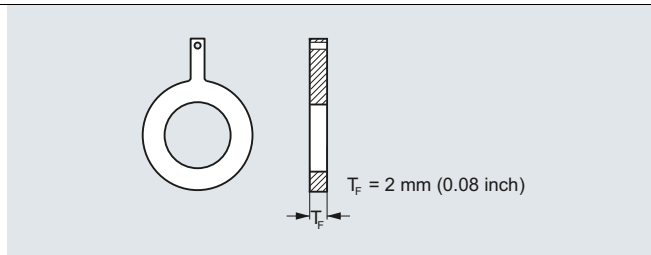

Size DN	Nominale pressure			Size Inch	ANSI	
	PN 6 Article No.	PN 16 Article No.	PN 40 Article No.		Class 150 Article No.	Class 300 Article No.
DN 15			<b>A5E01191981</b>	½"	<b>A5E01191989</b>	
DN 25			<b>A5E01150882</b>	1"	<b>A5E01150028</b>	<b>A5E01150379</b>
DN 40			<b>A5E01191982</b>	1½"	<b>A5E01191990</b>	
DN 50			<b>A5E01150922</b>	2"	<b>A5E01151124</b>	<b>A5E01151197</b>
DN 65		<b>A5E01191971</b>	<b>A5E01191983</b>	2½"	<b>A5E01191991</b>	
DN 80		<b>A5E01152889</b>	<b>A5E01152889</b>	3"	<b>A5E01152913</b>	<b>A5E01153424</b>
DN 100		<b>A5E01158886</b>	<b>A5E01159074</b>	4"	<b>A5E01159150</b>	<b>A5E01159629</b>
DN 125		<b>A5E01191973</b>	<b>A5E01191984</b>	5"	<b>A5E01191992</b>	
DN 150		<b>A5E01191974</b>	<b>A5E01191985</b>	6"	<b>A5E01191993</b>	
DN 200	<b>A5E01191978</b>	<b>A5E01191975</b>	<b>A5E01191986</b>	8"	<b>A5E01191994</b>	
DN 250	<b>A5E01191979</b>	<b>A5E01191976</b>	<b>A5E01191987</b>	10"	<b>A5E01191995</b>	
DN 300	<b>A5E01191980</b>	<b>A5E01191977</b>	<b>A5E01191988</b>	12"	<b>A5E01191996</b>	

**Grounding ring - Type Flat ring (Tantalum)**

- Material: Tantalum
- For all liners (PTFE max. 150 °C (302 °F))
- 1 pc. incl. straps and screws

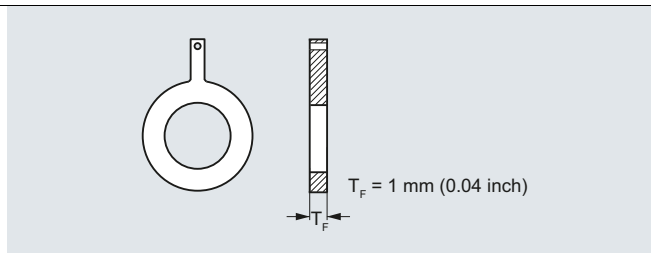

Size DN	Nominale pressure		Size Inch	ANSI	
	PN 16 Article No.	PN 40 Article No.		Class 150 Article No.	Class 300 Article No.
DN 15		<b>A5E01192007</b>	½"	<b>A5E01192010</b>	
DN 25		<b>A5E01150883</b>	1"	<b>A5E01150030</b>	<b>A5E01150381</b>
DN 40		<b>A5E01192008</b>	1½"	<b>A5E01192011</b>	
DN 50		<b>A5E01150926</b>	2"	<b>A5E01151129</b>	<b>A5E01151199</b>
DN 65	<b>A5E01192005</b>	<b>A5E01192009</b>	2½"	<b>A5E01192012</b>	
DN 80	<b>A5E01152890</b>	<b>A5E01152890</b>	3"	<b>A5E01152916</b>	<b>A5E01153427</b>
DN 100	<b>A5E01158891</b>	<b>A5E01159076</b>	4"	<b>A5E01159156</b>	<b>A5E01159631</b>

## Flow Measurement

SITRANS FM (electromagnetic)

Flow sensors

### MAG 3100 and MAG 3100 HT

#### Dimensional drawings

#### MAG 3100 and MAG 3100 HT sensor with compact or remote transmitter

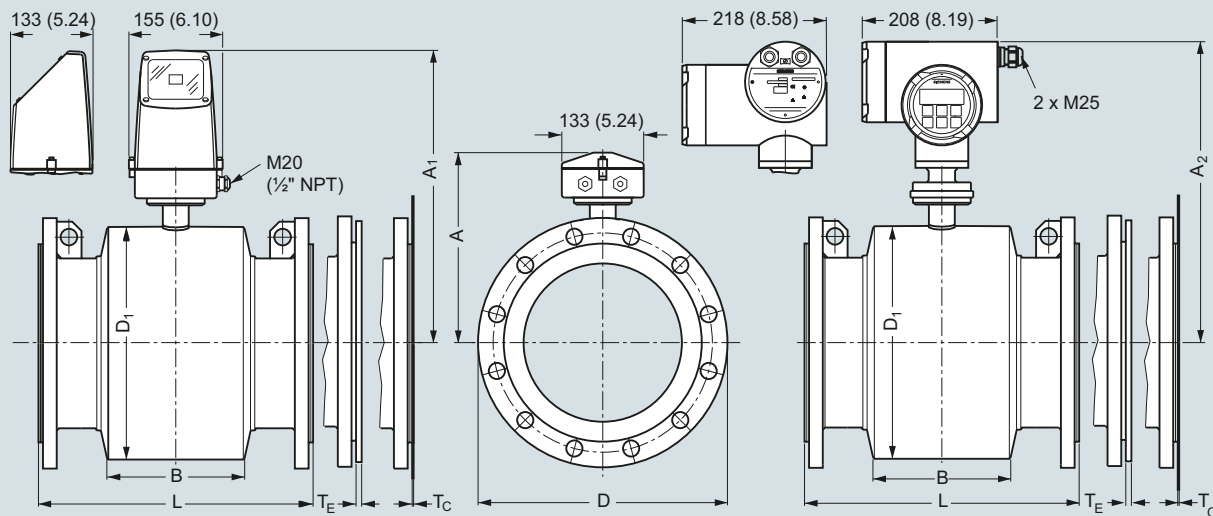

Dimensions in mm (inch)

Metric

DN	A <sup>1)</sup>	A <sub>1</sub>	A <sub>2</sub>	B	D <sub>1</sub>	L <sup>2)3)</sup>						ANSI 16.5		
						EN 1092-1-201	PN 6, 10	PN 16/PN 16 non-PED	PN 25	PN 40	PN 63	PN 100	Class 150	Class 300
[mm]	[mm]	[mm]	[mm]	[mm]	[mm]	[mm]	[mm]	[mm]	[mm]	[mm]	[mm]	[mm]	[mm]	[mm]
15	187	341	338	59	104	-	-	-	200	-	-	200	200	
25	187	341	338	59	104	-	-	-	200	-	260	200	200	
40	197	351	348	82	124	-	-	-	200	-	280	200	200	
50	205	359	356	72	139	-	-	-	200	276	300	200	200	
65	212	366	363	72	154	200	200/-	-	200	320	350	200	272	
80	222	376	373	72	174	200	200/-	-	272 <sup>4)</sup>	323	340	272 <sup>4)</sup>	272 <sup>4)</sup>	
100	242	396	393	85	214	250	250/-	-	250	380	400	250	310	
125	255	409	406	85	239	250	250/-	-	250	420	450	250	335	
150	276	430	427	85	282	300	300/-	-	300	415	450	300	300	
200	304	458	455	137	338	350	350/-	350	350	480	530	350	350	
250	332	486	483	157	393	450	450/-	450	450	550	620	450	450	
300	357	511	508	157	444	500	500/-	500	500	600	680	500	500	
350	362	516	513	270	451	550	550/-	550	550	-	-	550	550	
400	387	541	538	270	502	600	600/-	600	600	-	-	600	600	
450	418	572	569	310	563	600	600/-	600	600	-	-	600	640	
500	443	597	594	350	614	600	600/-	625	680	-	-	600	730	
600	494	648	645	320	715	600	600/-	750	800	-	-	600	860	
700	544	698	695	450	816	700	875/700	800	-	-	-	800	-	
750	571	725	722	556	869	-	-/-	-	-	-	-	950	-	
800	606	760	757	560	927	800	1000/800	900	-	-	-	900	-	
900	653	807	804	630	1032	900	1125/900	1000	-	-	-	1100	-	
1000	704	858	855	670	1136	1000	1250/1000	1100	-	-	-	1100	-	
1050	704	858	855	670	1136	-	-/-	-	-	-	-	-	-	
1100	755	904	901	770	1238	-	-/-	-	-	-	-	-	-	
1200	810	964	961	792	1348	1200	1500/1200	1300	-	-	-	1400	-	
1400	925	1079	1076	1000	1574	1400	-/1400	-	-	-	-	-	-	
1500	972	1126	1123	1020	1672	1500	-/1500	-	-	-	-	-	-	
1600	1025	1179	1176	1130	1774	1600	-/1600	-	-	-	-	-	-	
1800	1123	1277	1274	1250	1974	1800	-/1800	-	-	-	-	-	-	
2000	1223	1377	1374	1375	2174	2000	-/2000	-	-	-	-	-	-	

1) 14.5 mm shorter with stainless steel terminal box (Ex and high temperature version)

2) When grounding rings are used, the thickness of the grounding ring must be added to the built-in length

3) Tolerances on built-in length (PN 6, PN 10, PN 16, PN 25 and PN 40):

DN 15 to DN 200: +0/-3 mm, DN 250 to DN 400: +0/-5 mm, DN 450 to DN 600: +5/-5 mm, DN 700 to DN 2000: +10/-10 mm

Tolerances on built-in length (PN 63 and PN 100): All sizes +8/-8 mm

4) Not according to ISO 20456

**Dimensional drawings** (continued)

DN	L <sup>1)2)</sup>	AWWA C-207 Class D	JIS K10	JIS K20	T <sub>C</sub> <sup>3)</sup>	T <sub>E</sub> <sup>3)</sup>	T <sub>F</sub> <sup>3)</sup>	Weight <sup>4)</sup>
[mm]	AS 2129 E AS 4087 PN 16, 21, 35 [mm]	[mm]	[mm]	[mm]	[mm]	[mm]	[mm]	[kg]
15	200	-	200	200	-	6	2	4
25	200	-	200	200	1.2	6	2	5
40	200	-	200	240	1.2	6	2	8
50	200	-	200	240	1.2	6	2	9
65	200	-	200	272	1.2	6	2	11
80	200 <sup>5)</sup>	-	200 <sup>9)</sup>	272 <sup>9)</sup>	1.2	6	2	12
100	250	-	250	310	1.2	6	2	16
125	250	-	250	335	1.2	6	2	19
150	300	-	300	300	1.2	6	2	27
200	350	-	350	350	1.2	8	2	40
250	450	-	450	450	1.2	8	2	60
300	500	-	500	500	1.6	8	2	80
350	550	-	550	550	1.6	8	-	110
400	600	-	600	600	1.6	10	-	125
450	600	-	600	640	1.6	10	-	175
500	600 <sup>6)</sup>	-	600	680	1.6	10	-	200
600	600 <sup>7)</sup>	-	600	800	1.6	10	-	287
700	700 <sup>8)</sup>	700	-	-	2.0	-	-	330
750	750 <sup>8)</sup>	750	-	-	2.0	-	-	360
800	800 <sup>8)</sup>	800	-	-	2.0	-	-	450
900	900 <sup>8)</sup>	900	-	-	2.0	-	-	530
1000	1000 <sup>8)</sup>	1000	-	-	2.0	-	-	660
1050	-	1000	-	-	2.0	-	-	660
1100	-	1100	-	-	2.0	-	-	1140
1200	1200 <sup>6)</sup>	1200	-	-	2.0	-	-	1180
1400	-	1400	-	-	2.0	-	-	1600
1500	-	1500	-	-	3.0	-	-	2460
1600	-	1600	-	-	3.0	-	-	2525
1800	-	1800	-	-	3.0	-	-	2930
2000	-	2000	-	-	3.0	-	-	3665

1) When grounding rings are used, the thickness of the grounding ring must be added to the built-in length.

2) Tolerances on built-in length (PN 6, PN 10, PN 16, PN 25 and PN 40):

DN 15 to DN 200: +0/-3 mm, DN 250 to DN 400: +0/-5 mm, DN 450 to DN 600: +5/-5 mm, DN 700 to DN 2000: +10/-10 mm

Tolerances on built-in length (PN 63 and PN 100): All sizes +8/-8 mm

3) T<sub>C</sub> = Protection ring type C, T<sub>E</sub> = Grounding ring type E (included and factory mounted for 180 °C PTFE liner), T<sub>F</sub> = Grounding ring Type Flat ring

4) Weights are approx. (for PN 16) without transmitter.

5) PN 35 DN 80 = 272 mm (not according to ISO 20456)

6) PN 35 DN 500 = 680 mm

7) PN 35 DN 600 = 750 mm

8) Not AS 4087 PN 21 or PN 35

9) Not according to ISO 20456

D = Outside diameter of flange, see flange tables

## Flow Measurement

SITRANS FM (electromagnetic)

Flow sensors

### MAG 3100 and MAG 3100 HT

#### Dimensional drawings (continued)

Imperial

DN	A <sup>1)</sup>	A <sub>1</sub>	A <sub>2</sub>	B	D <sub>1</sub>	L <sup>2)3)</sup>						ANSI 16.5/ASME B16.47 <sup>4)</sup>		
						EN 1092-1-201						Class 150	Class 300	Class 600
[inch]	[inch]	[inch]	[inch]	[inch]	[inch]	PN 6, 10	PN 16/PN 16 non-PED	PN 25	PN 40	PN 63	PN 100	[inch]	[inch]	[inch]
½	7.36	13.31	13.25	2.32	4.09	-	-	-	7.87	-	-	7.87	7.87	-
1	7.36	13.31	13.25	2.32	4.09	-	-	-	7.87	-	10.24	7.87	7.87	11.02
1½	7.76	13.70	13.64	3.23	4.88	-	-	-	7.87	-	11.02	7.87	7.87	12.60
2	8.07	14.01	13.95	2.83	5.47	-	-	-	7.87	10.87	11.81	7.87	7.87	12.99
2½	8.35	14.29	14.23	2.83	6.06	7.87	7.87/-	-	7.87	12.60	13.78	7.87	10.71	on request
3	8.74	14.69	14.63	2.83	6.85	7.87	7.87/-	-	10.71 <sup>5)</sup>	12.72	13.39	10.71 <sup>5)</sup>	10.71 <sup>5)</sup>	13.78
4	9.53	15.47	15.41	3.35	8.43	9.84	9.84/-	-	9.84	14.96	-	9.84	12.20	18.11
5	10.04	15.98	15.92	3.35	9.41	9.84	9.84/-	-	9.84	16.54	-	9.84	13.10	18.90
6	10.87	16.81	16.75	5.39	11.10	11.81	11.81/-	-	11.81	16.34	-	11.81	11.81	19.68
8	11.97	17.91	17.85	5.39	13.31	13.78	13.78/-	13.78	13.78	18.90	-	13.78	13.78	23.62
10	13.07	19.02	18.96	6.18	15.47	17.72	17.72/-	17.72	17.72	-	-	17.72	17.72	23.62
12	14.05	20.00	19.94	6.18	17.48	19.69	19.69/-	19.69	19.69	-	-	19.69	19.69	27.56
14	14.25	20.20	20.14	10.63	17.76	21.65	21.65/-	21.65	21.65	-	-	21.65	21.65	-
16	15.24	21.18	21.12	10.63	19.76	23.62	23.62/-	23.62	23.62	-	-	23.62	23.62	-
18	16.45	22.40	22.34	12.20	22.16	23.62	23.62/-	23.62	23.62	-	-	23.62	23.62	-
20	17.44	23.39	23.33	13.78	24.17	23.62	23.62/-	24.61	26.77	-	-	23.62	28.70	-
24	19.45	25.39	25.33	12.59	28.15	23.62	23.62/-	29.53	31.50	-	-	23.62	33.80	-
28	21.42	27.36	27.30	17.72	32.13	27.56	34.45/27.56	31.50	-	-	-	31.50	-	-
30	22.48	28.43	28.37	21.89	34.21	-	-	-	-	-	-	37.41	-	-
32	23.86	29.80	29.74	22.05	36.50	31.50	39.37/31.50	35.44	-	-	-	35.44	-	-
36	25.71	31.65	31.59	24.80	40.63	35.43	44.29/35.43	39.38	-	-	-	43.32	-	-
40	27.72	33.85	33.79	26.38	44.72	39.37	49.21/39.37	43.32	-	-	-	43.32	-	-
42	27.72	33.85	33.79	26.38	44.72	-	-	-	-	-	-	-	-	-
44	29.72	35.67	35.61	30.31	48.74	-	-	-	-	-	-	-	-	-
48	31.89	37.83	37.77	31.18	53.07	47.24	59.06/47.24	51.19	-	-	-	55.12	-	-
54	36.42	42.36	42.30	39.37	61.97	55.12	-/55.12	-	-	-	-	-	-	-
60	38.27	44.21	44.15	40.15	65.83	59.06	59.06/59.06	-	-	-	-	-	-	-
66	40.35	46.30	46.24	44.49	69.84	62.99	-/62.99	-	-	-	-	-	-	-
72	44.21	50.16	50.10	49.21	77.72	70.87	-/70.87	-	-	-	-	-	-	-
78	48.15	54.09	54.03	54.13	85.59	78.74	-/78.74	-	-	-	-	-	-	-

<sup>1)</sup> 0.571 inch shorter with stainless steel terminal box (Ex and high temperature version)

<sup>2)</sup> When grounding rings are used, the thickness of the grounding ring must be added to the built-in length

<sup>3)</sup> Tolerances on built-in length (PN 6, PN 10, PN 16, PN 25 and PN 40):

½" to 8": +0/-0.12", 10" to DN 16": +0/-0.20", 18" to DN 24": +0.20/-0.20", 28" to DN 78": +0.39/-0.39"

Tolerances on built-in length (PN 63 and PN 100): All sizes +0.31"/-0.31"

<sup>4)</sup> ANSI 16.5 for DN ≤ 24"; ASME B16.47 for DN ≥ 28"

<sup>5)</sup> Not according to ISO 20456

**Dimensional drawings** (continued)

DN	L <sup>1)2)</sup>	AS 2129 E AS 4087 PN 16, 21, 35	AWWA C-207 Class D	JIS K10	JIS K20	T <sub>C</sub> <sup>3)</sup>	T <sub>E</sub> <sup>3)</sup>	T <sub>F</sub> <sup>3)</sup>	Weight <sup>4)</sup>
[inch]	[inch]	[inch]	[inch]	[inch]	[inch]	[inch]	[inch]	[inch]	[lb]
½	7.87	-	7.87	7.87	-	0.24	0.08	9	
1	7.87	-	7.87	7.87	0.05	0.24	0.08	11	
1½	7.87	-	7.87	9.44	0.05	0.24	0.08	17	
2	7.87	-	7.87	9.44	0.05	0.24	0.08	20	
2½	7.87	-	7.87	10.70	0.05	0.24	0.08	24	
3	7.875)	-	7.878)	10.709)	0.05	0.24	0.08	26	
4	9.84	-	9.84	12.20	0.05	0.24	0.08	35	
5	9.84	-	9.84	13.18	0.05	0.24	0.08	42	
6	11.81	-	11.81	11.81	0.05	0.24	0.08	60	
8	13.78	-	13.77	13.77	0.05	0.31	0.08	88	
10	17.72	-	17.71	17.71	0.05	0.31	0.08	132	
12	19.69	-	19.68	19.68	0.06	0.31	0.08	176	
14	21.65	-	21.65	21.65	0.06	0.31	-	242	
16	23.62	-	23.62	23.62	0.06	0.39	-	275	
18	23.62	-	23.62	25.19	0.06	0.39	-	385	
20	23.626)	-	23.62	26.77	0.06	0.39	-	440	
24	23.627)	-	23.62	31.49	0.06	0.39	-	633	
28	27.568)	27.56	-	-	0.08	-	-	728	
30	29.538)	29.52	-	-	0.08	-	-	794	
32	31.807)	31.50	-	-	0.08	-	-	992	
36	35.438)	35.43	-	-	0.08	-	-	1168	
40	39.378)	39.37	-	-	0.08	-	-	1455	
42	-	39.37	-	-	0.08	-	-	1455	
44	-	43.31	-	-	0.08	-	-	2513	
48	47.248)	47.24	-	-	0.08	-	-	2601	
54	-	55.12	-	-	0.12	-	-	3528	
60	-	59.06	-	-	0.12	-	-	5423	
66	-	63.00	-	-	0.12	-	-	5566	
72	-	70.87	-	-	0.12	-	-	6460	
78	-	78.74	-	-	0.12	-	-	8080	

1) When grounding rings are used, the thickness of the grounding ring must be added to the built-in length.

2) Tolerances on built-in length (PN 6, PN 10, PN 16, PN 25 and PN 40):  
 ½" to 8": +0/-0.12", 10" to 16": +0/-0.20", 18" to 24": +0.2/-0.2", 28" to 78": +0.39/-0.39"  
 Tolerances on built-in length (PN 63 and PN 100): All sizes +0.31"/-0.31"

3) T<sub>C</sub> = Protection ring type C, T<sub>E</sub> = Grounding ring type E (included and factory mounted for 180 °C PTFE liner), T<sub>F</sub> = Grounding ring Type Flat ring

4) Weights are for ANSI 150 without transmitter.

5) PN 35 DN 80 = 10.07 inch

6) PN 35 DN 500 = 26.77 inch

7) PN 35 DN 600 = 2.53 inch

8) Not AS 4087 PN 21 or PN 35

9) Not according to ISO 20456

D = Outside diameter of flange, see flange tables