

Temperature measurement

Temperature transmitters

Field transmitters/field indicator

SITRANS TF - Transmitter, 2-wire system and SITRANS TF - Field indicator for 4 to 20 mA

Overview



Our field devices for heavy industrial use

- HART, Universal
- 4 to 20 mA, universal
- Field indicator for 4 to 20 mA signals

The temperature transmitter SITRANS TF works where others feel uncomfortable.

Benefits

- Universal use
 - as transmitter for resistance thermometer, thermocouple element, Ω or mV signal
 - as field indicator for any 4 to 20 mA signals
- Local sensing of measured values over digital display
- Rugged two-chamber enclosure in die-cast aluminum or stainless steel
- IP66/67/68 degree of protection
- Test terminals for direct read-out of the output signal without breaking the current loop
- Can be mounted elsewhere if the measuring point
 - is difficult to access
 - has high temperatures
 - experiences vibrations due to the process cell
 - is to avoid long neck pipes and thermowells
- Can be mounted directly on American-design sensors
- Wide range of approvals for use in potentially explosive atmospheres. Types of protection "Intrinsically safe, non-sparking and flameproof", for Europe and the USA.
- SIL2 (with order note C20), SIL2/3 (with C23)

Application

SITRANS TF can be used everywhere where temperatures need to be measured under particularly adverse conditions, or where a convenient local display is ideal. Which is why users from all industries have opted for this field device. The rugged enclosure protects the electronics. The stainless steel model is almost completely resistant to sea water and other aggressive substances. The inner workings offer high measuring accuracy, universal input and a wide range of diagnostic options.

Function

Configuration

The communication capability over the HART protocol V 5.9 of the SITRANS TF with an integrated SITRANS TH300 permits parameterization using a PC or HART communicator (hand-held communicator). The SIMATIC PDM makes it easy.

For the SITRANS TF with integrated programmable SITRANS TH200, parameters are assigned with the PC. Available for this purpose are a special modem and the software tool SIPROM T.

Mode of operation

Mode of operation of SITRANS TF as temperature transmitter

The sensor signal, whether resistance thermometer, thermocouple element or Ω or mV signal, is amplified and linearized. Sensor and output side are electrically isolated. An internal cold junction is integrated for measurements with thermocouples.

The device outputs a temperature-linear direct current of 4 to 20 mA. As well as the analog transmission of measured values from 4 to 20 mA, the HART version also supports digital communication for online diagnostics, measured value transmission and configuration.

SITRANS TF automatically detects when a sensor should be interrupted or is indicating a short-circuit. The practical test terminals allow direct measurement of 4 to 20 mA signals over an ammeter without interrupting the output current loop.

Mode of operation of SITRANS TF as field indicator

Any 4 to 20 mA signal can be applied to the generous terminal block. As well as a range of predefined measurement units, the adjustable indicator also supports the input of customized units. This means that any 4 to 20 mA signal can be represented in any unit, e.g. pressure, flow rate, level or temperature.

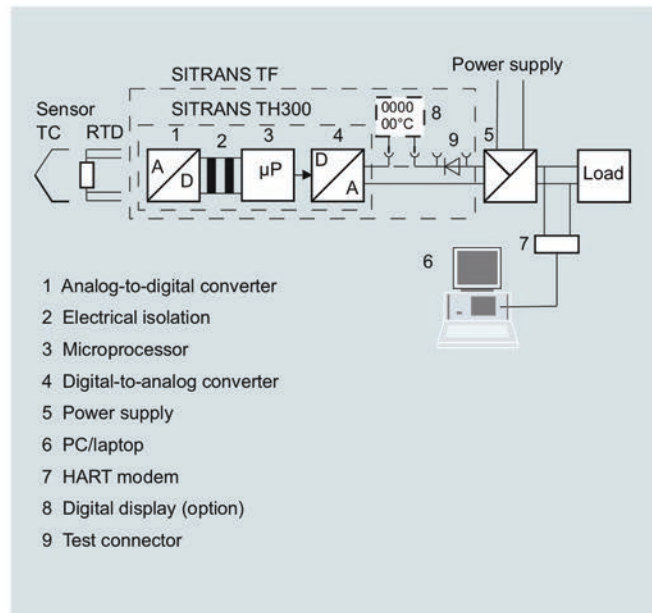

Mode of operation of SITRANS TF with integrated SITRANS TH300 and digital display

Technical specifications

Input

Resistance thermometer

Measured variable	Temperature
Input type	
• According to IEC 60751	Pt25 ... Pt1000
• Acc. to JIS C 1604; a=0.00392 K-1	Pt25 ... Pt1000
• According to IEC 60751	Ni25 ... Ni1000
Units	°C and °F
Connection	
• Standard connection	1 resistance thermometer (RTD) in 2-wire, 3-wire or 4-wire connection
• Averaging	Series or parallel connection of several resistance thermometers in the 2-wire connection for the generation of average temperatures or for adaptation to other device types
• Differentiation	2 resistance thermometers (RTD) in 2-wire connection (RTD 1 – RTD 2 or RTD 2 – RTD 1)
Connection	
• 2-wire connection	Line resistance can be configured $\leq 100 \Omega$ (loop resistance)
• 3-wire connection	No trim necessary
• 4-wire connection	No trim necessary
Sensor current	$\leq 0.45 \text{ mA}$
Response time	$\leq 250 \text{ ms}$ for 1 sensor with break monitoring
Break monitoring	Always active (cannot be switched off)
Short-circuit monitoring	Can be switched on/off (default value: ON)
Measuring range	Assignable (see "Digital measuring error" table)
Min. measuring span	10 °C (18 °F)
Characteristic curve	Temperature-linear or special characteristic

Resistance-based sensor

Measured variable	Actual resistance
Sensor type	Resistance-based, potentiometers
Units	Ω
Connection	
• Standard connection	1 resistance-based sensor (R) in 2-wire, 3-wire or 4-wire connection
• Averaging	2 resistance-based sensors in 2-wire connection for averaging
• Differentiation	2 resistance-based sensors in 2-wire connection (R 1 – R 2 or R 2 – R 1)
Connection	
• 2-wire connection	Line resistance can be configured $\leq 100 \Omega$ (loop resistance)
• 3-wire connection	No trim necessary
• 4-wire connection	No trim necessary
Sensor current	$\leq 0.45 \text{ mA}$
Response time	$\leq 250 \text{ ms}$ for 1 sensor with break monitoring
Break monitoring	Can be switched off
Short-circuit monitoring	Can be switched off (value is adjustable)
Measuring range	Assignable max. 0 ... 2200 Ω (see "Digital measuring error" table)
Min. measuring span	5 ... 25 Ω (see "Digital measuring error" table)
Characteristic curve	Resistance-linear or special characteristic

Thermocouples

Measured variable	Temperature
Sensor type (thermocouples)	
• Type B	Pt30Rh-Pt6Rh acc. to IEC 584
• Type C	W5%-Re acc. to ASTM 988
• Type D	W3%-Re acc. to ASTM 988
• Type E	NiCr-CuNi acc. to IEC 584
• Type J	Fe-CuNi acc. to IEC 584
• Type K	NiCr-Ni acc. to IEC 584
• Type L	Fe-CuNi acc. to DIN 43710
• Type N	NiCrSi-NiSi acc. to IEC 584
• Type R	Pt13Rh-Pt acc. to IEC 584
• Type S	Pt10Rh-Pt acc. to IEC 584
• Type T	Cu-CuNi acc. to IEC 584
• Type U	Cu-CuNi acc. to DIN 43710
Units	°C or °F
Connection	
• Standard connection	1 thermocouple (TC)
• Averaging	2 thermocouples (TC)
• Differentiation	2 thermocouples (TC) (TC 1 – TC 2 or TC 2 – TC 1)
Response time	$\leq 250 \text{ ms}$ for 1 sensor with break monitoring
Break monitoring	Can be switched off
Reference junction compensation	
• Internal	With integrated Pt100 resistance thermometer
• External	With external Pt100 IEC 60751 (2-wire or 3-wire connection)
• External fixed	Reference junction temperature can be set as fixed value
Measuring range	Assignable (see "Digital measuring error" table)
Min. measuring span	Min. 40 ... 100 °C (72 ... 180 °F) (see "Digital measuring error" table)
Characteristic curve	Temperature-linear or special characteristic

mV sensor

Measured variable	DC voltage
Sensor type	DC voltage source (DC voltage source possible over an externally connected resistor)
Units	mV
Response time	$\leq 250 \text{ ms}$ for 1 sensor with break monitoring
Break monitoring	Can be switched off
Measuring range	-10 ... +70 mV -100 ... +1100 mV
Min. measuring span	2 mV or 20 mV
Overload capability of the input	-1.5 ... +3.5 V DC
Input resistance	$\geq 1 \text{ M}\Omega$
Characteristic curve	Voltage-linear or special characteristic

Temperature measurement

Temperature transmitters

Field transmitters/field indicator

SITRANS TF - Transmitter, 2-wire system and SITRANS TF - Field indicator for 4 to 20 mA

Output	
Output signal	4 ... 20 mA, 2-wire
Communication with SITRANS TH300	According to HART Rev. 5.9
Digital display	
Digital display (optional)	In current loop
Display	Max. 5 digits
Digit height	9 mm (0.35")
Display range	-99 999 ... +99 999
Units	Any (max. 5 char.)
Setting: Zero point, full-scale value and unit	Using 3 buttons
Load voltage	2.1 V
Measuring accuracy	
Digital measuring error	See "Digital measuring error" table
Reference conditions	
• Auxiliary power	24 V ± 1 %
• Load	500 Ω
• Ambient temperature	23 °C (73.4 °F)
• Warming-up time	> 5 min
Error in the analog output (digital/analog converter)	< 0.025 % of measuring span
Error due to internal reference junction	< 0.5 °C (0.9 °F)
Effect of ambient temperature	
• Analog measuring error	0.02 % of meas. span/10 °C (18 °F)
• Digital measuring error	
• with resistance thermometers	0.06 °C (0.11 °F)/10°C (18 °F)
• with thermocouples	0.6 °C (1.1 °F)/10°C (18 °F)
Auxiliary power effect	< 0.001 % of meas. span/V
Effect of load impedance	< 0.002 % of meas. span/100 Ω
Long-term drift	
• In the first month	< 0.02 % of measuring span
• After one year	< 0.2 % of measuring span
• After 5 years	< 0.3 % of measuring span
Rated conditions	
<u>Ambient conditions</u>	
Ambient temperature	-40 ... +85 °C (-40 ... +185 °F)
Condensation	Permissible
Electromagnetic compatibility	According to EN 61326 and NAMUR NE21
Degree of protection acc. to EN 60529	IP66/67/68
Design	
Weight	Approx. 1.5 kg (3.3 lb) without options
Dimensions	See "Dimensional drawings"
Enclosure material	Die-cast aluminum, low in copper, GD-AISI 12 or stainless steel, polyester-based lacquer, stainless steel rating plate
Electrical connection, sensor connection	Screw terminals, cable inlet via M20 x 1.5 or ½-14 NPT screwed gland
Mounting bracket (optional)	Steel, galvanized and chrome-plated or stainless steel
Auxiliary power	
Without digital display	11 ... 35 V DC (30 V with Ex ib; 32 V with Ex ic and Ex nA)
With digital display	13.1 ... 35 V DC (30 V with Ex ib; 32 V with Ex ic and Ex nA)
Galvanic isolation	Between input and output
• Test voltage	$U_{\text{eff}} = 1 \text{ kV}$, 50 Hz, 1 min

Certificates and approvals	
Explosion protection ATEX	
• "Intrinsic safety" type of protection	With digital display: II 2 (1) G Ex ib [ia Ga] IIC T4 Gb II 2 G Ex ib IIC T4 Gb II 2 D Ex ia IIIC T100°C Db
	Without digital display: II 2 (1) G Ex ib [ia Ga] IIC T6 Gb II 2 G Ex ib IIC T6 Gb II 2 D Ex ia IIIC T100°C Db
• EC type-examination certificate	ZELM 11 ATEX 0471 X
• "Non-sparking and energy-limited equipment for Zone 2" type of protection	II 3 G Ex ic IIC T6/T4 Gc II 3 G Ex nA IIC T6/T4 Gc II 3 G Ex nA [ic] IIC T6/T4 Gc
• EC type-examination certificate	ZELM 11 ATEX 0471 X
• "Flameproof enclosure" type of protection	II 2 G Ex d IIC T6/T5 Gb II 2 D Ex tb IIIC T100 °C Db
• EC type-examination certificate	ZELM 11 ATEX 0472 X
Explosion protection acc. to FM	Certificate of Compliance 3017742
• Identification (XP, DIP, NI, S)	• XP/II/BCD/T5 Ta = 85 °C (185 °F), T6 Ta = 60 °C (140 °F), Type 4X
	• DIP/II, III/1/EFG/T5 Ta = 85 °C (185 °F), T6 Ta = 60 °C (140 °F), Type 4X
	• NI/II, III/2/FG/T5 Ta = 85 °C (185 °F), T6 Ta = 60 °C (140 °F), Type 4X
Other certificates	IECEX, EAC Ex(GOST), INMETRO, NEPSI, KOSHA
Hardware and software requirements	
• For the SIPROM T parameterization software for SITRANS TF with TH200	
• Personal computer	PC with CD-ROM drive and USB interface
• PC operating system	Windows 98, NT, 2000, XP, 7 and Win 8
• For the SIMATIC PDM parameterization software for SITRANS TH300	See section 8 "Digitalization and communication", "SIMATIC PDM"
Communication	
Load for HART connection	230 ... 1100 Ω
• Two-core shielded	≤ 3.0 km (1.86 mi)
• Multi-core shielded	≤ 1.5 km (0.93 mi)
Protocol	HART protocol, version 5.9

Factory setting of the transmitter:

- Pt100 (IEC 751); 3-wire connection
- Measuring range: 0 ... 100 °C (32 ... 212 °F)
- Fault current: 22.8 mA
- Sensor offset: 0 °C (0 °F)
- Damping 0.0 s

Digital measuring error

Resistance thermometer

Input	Measuring range °C (°F)	Minimum measuring span		Digital accuracy	
		°C	(°F)	°C	(°F)
According to IEC 60751					
Pt25	-200 ... +850 (-328 ... +1562)	10	(18)	0.3	(0.54)
Pt50	-200 ... +850 (-328 ... +1562)	10	(18)	0.15	(0.27)
Pt100 ... Pt200	-200 ... +850 (-328 ... +1562)	10	(18)	0.1	(0.18)
Pt500	-200 ... +850 (-328 ... +1562)	10	(18)	0.15	(0.27)
Pt1000	-200 ... +350 (-328 ... +662)	10	(18)	0.15	(0.27)
According to JIS C1604-81					
Pt25	-200 ... +649 (-328 ... +1200)	10	(18)	0.3	(0.54)
Pt50	-200 ... +649 (-328 ... +1200)	10	(18)	0.15	(0.27)
Pt100 ... Pt200	-200 ... +649 (-328 ... +1200)	10	(18)	0.1	(0.18)
Pt500	-200 ... +649 (-328 ... +1200)	10	(18)	0.15	(0.27)
Pt1000	-200 ... +350 (-328 ... +662)	10	(18)	0.15	(0.27)
Ni 25 ... Ni1000	-60 ... +250 (-76 ... +482)	10	(18)	0.1	(0.18)

Resistance-based sensor

Input	Measuring range Ω	Minimum measuring span Ω	Digital accuracy
			Ω
Resistance	0 ... 390	5	0.05
Resistance	0 ... 2200	25	0.25

Thermocouples

Input	Measuring range °C (°F)	Minimum measuring span		Digital accuracy	
		°C	(°F)	°C	(°F)
Type B	100 ... 1820 (212 ... 3308)	100	(180)	2 ¹⁾	(3.6) ¹⁾
Type C (W5)	0 ... 2300 (32 ... 4172)	100	(180)	2	3.6
Type D (W3)	0 ... 2300 (32 ... 4172)	100	(180)	1 ²⁾	(1.8) ²⁾
Type E	-200 ... +1000 (-328 ... +1832)	50	(90)	1	(1.8)
Type J	-200 ... +1200 (-328 ... +2192)	50	(90)	1	(1.8)
Type K	-200 ... +1370 (-328 ... +2498)	50	(90)	1	(1.8)
Type L	-200 ... +900 (-328 ... +1652)	50	(90)	1	(1.8)
Type N	-200 ... +1300 (-328 ... +2372)	50	(90)	1	(1.8)
Type R	-50 ... +1760 (-58 ... +3200)	100	(180)	2	(3.6)
Type S	-50 ... +1760 (-58 ... +3200)	100	(180)	2	(3.6)
Type T	-20 ... +400 (-328 ... +752)	40	(72)	1	(1.8)
Type U	-200 ... +600 (-328 ... +1112)	50	(90)	2	(3.6)

¹⁾ The digital accuracy in the range 100 to 300 °C (212 to 572 °F) is 3 °C (5.4 °F).

²⁾ The digital accuracy in the range 1750 to 2300 °C (3182 to 4172 °F) is 2 °C (3.6 °F).

mV sensor

Input	Measuring range mV	Minimum measuring span mV	Digital accuracy
			μV
mV sensor	-10 ... +70	2	40
mV sensor	-100 ... +1100	20	400

The digital accuracy is the accuracy after the analog/digital conversion including linearization and calculation of the measured value.

An additional error is generated in the output current 4 to 20 mA as a result of the digital/analog conversion of 0.025% of the set measuring span (digital-analog error).

The total error under reference conditions at the analog output is the sum from the digital error and the digital-analog error (poss. with the addition of reference junction errors in the case of thermocouple measurements).



Temperature measurement

Temperature transmitters

Field transmitters/field indicator

SITRANS TF - Transmitter, 2-wire system and SITRANS TF - Field indicator for 4 to 20 mA

Selection and ordering data

	Article No.	Options	Order code
Temperature transmitter in field enclosure  2-wire system 4 ... 20 mA, with electrical isolation  Click on the Article No. for the online configuration in the PIA Life Cycle Portal.	7NG313 - - - - -	Append suffix "-Z" to article no., add order code and plain text, if applicable.	
Built-in transmitter SITRANS TH200, programmable <ul style="list-style-type: none"> Without Ex protection With Ex ia (ATEX + IECEx) With Ex nAL for Zone 2 (ATEX + IECEx) Total device SITRANS TF Ex d (ATEX + IECEx)¹⁾ Total device SITRANS TF according to FM (XP, DIP, NI, S)¹⁾ SITRANS TH300, communication-capable according to HART V 5.9 <ul style="list-style-type: none"> Without Ex protection With Ex ia (ATEX + IECEx) With Ex nAL for Zone 2 (ATEX + IECEx) Total device SITRANS TF Ex d (ATEX + IECEx)¹⁾ Total device SITRANS TF according to FM (XP, DIP, NI, S)¹⁾ 	5 0 5 1 5 2 5 4 5 5 6 0 6 1 6 2 6 4 6 5	Test report (5 measuring points) Functional safety SIL2 Functional safety SIL2/3 Explosion protection <ul style="list-style-type: none"> Explosion protection Ex ia according to INMETRO (Brazil) (only for 7NG313.-1...) Explosion protection Ex d according to INMETRO (Brazil) (only for 7NG313.-4...) Explosion protection Ex nA according to INMETRO (Brazil) (only for 7NG313.-2...) Explosion protection Ex i according to NEPSI (China) (only for 7NG313.-1...) Explosion protection Ex d according to NEPSI (China) (only for 7NG313.-4...) Explosion protection Ex nA according to NEPSI (China) (only for 7NG313.-2...) Explosion protection Ex d according to KOSHA (Korea) (only for 7NG313.-4...) Explosion protection Ex i according to EAC (Russia/Belarus/Kazakhstan) (only for 7NG313.-1...) Explosion protection Ex d according to EAC (Russia/Belarus/Kazakhstan) (only for 7NG313.-4...) Explosion protection Ex nA according to EAC (Russia/Belarus/Kazakhstan) (only for 7NG313.-2...) 	C11 C20 C23 E25 ¹⁾ E26 ¹⁾ E27 ¹⁾ E55 ¹⁾ E56 ¹⁾ E57 ¹⁾ E70 ¹⁾ E81 ¹⁾ E82 ¹⁾ E83 ¹⁾
Enclosure Die-cast aluminum Stainless steel precision casting	A E	Marine approvals <ul style="list-style-type: none"> Det Norske Veritas Germanischer Lloyd (DNV GL) Bureau Veritas (BV) Lloyd's Register of Shipping (LR) American Bureau of Shipping (ABS) 	D01 D02 D04 D05
Connections/cable inlet Screwed glands M20x1.5 ½-14 NPT glands	B C	Two-layer coating of enclosure and cover (PU on epoxy) Transient protection	G10 J01
Digital indicator Without With	0 1	Cable gland CAPRI ½ NPT ADE 4F, nickel-plated brass (CAPRI 848694 and 810634) included Cable gland ½ NPT ADE 1F, cable diameter 6 ... 12 (CAPRI 818694 and 810534) included Cable gland ½ NPT ADE 4F, Stainless steel (CAPRI 848699 and 810634) included Cable gland ½ NPT ADE 1F, cable diameter 4 ... 8.5 (CAPRI 818674 and 810534) included	D57 D58 D59 D60
Mounting bracket and fastening parts Without Made of steel Made of stainless steel	0 1 2		

¹⁾ Without cable gland.

Temperature measurement

Temperature transmitters

Field transmitters/field indicator

SITRANS TF - Transmitter, 2-wire system and SITRANS TF - Field indicator for 4 to 20 mA

Options	Order code
Append suffix "-Z" to article no., add order code and plain text, if applicable.	
Customer-specific programming	
Measuring range to be set Specify in plain text (max. 5 digits): Y01:... to ... °C, °F	Y01²⁾
Measuring point number (TAG) max. 8 characters	Y17³⁾
Measuring point description, max. 16 characters	Y23⁴⁾
Measuring point description, max. 32 characters	Y24⁴⁾
Labeling of measuring point plate only, specify in plain text: Measuring range	Y22⁴⁾
Pt100 (IEC) 2-wire, $R_L = 0 \Omega$	U02⁵⁾
Pt100 (IEC) 3-wire	U03⁵⁾
Pt100 (IEC) 4-wire	U04⁵⁾
Type B thermocouple	U20⁵⁾⁶⁾
Type C thermocouple (W5)	U21⁵⁾⁶⁾
Type D thermocouple (W3) ⁵⁾⁶⁾	U22⁵⁾⁶⁾
Type E thermocouple	U23⁵⁾⁶⁾
Type J thermocouple	U24⁵⁾⁶⁾
Type K thermocouple	U25⁵⁾⁶⁾
Type L thermocouple	U26⁵⁾⁶⁾
Type N thermocouple	U27⁵⁾⁶⁾
Type R thermocouple	U28⁵⁾⁶⁾
Type S thermocouple	U29⁵⁾⁶⁾
Type T thermocouple	U30⁵⁾⁶⁾
Type U thermocouple	U31⁵⁾⁶⁾
For TC: Cold junction compensation: external (Pt100, 3-wire)	U41
For TC: Reference junction compensation: external with fixed value: specify in plain text	Y50
Enter special deviating customer-specific setting in plain text	Y09⁷⁾
Fault current 3.6 mA (instead of 22.8 mA)	U36³⁾

- 1) ¹⁾ Option does not include ATEX/IECEx approval, only country-specific approval.
- 2) For customer-specific programming for RTD and TC, the start value and the end value of the required measuring span must be specified here. For specification on TAG plate, please select Y22.
- 3) For this selection, Y01 or Y09 must also be selected. For specification on TAG plate, please select Y23.
- 4) If only Y22, Y23 or Y24 is ordered and if the labeling is only noted on the measuring point plate, do not specify Y01.
- 5) For this selection, Y01 must also be selected.
- 6) Internal reference junction compensation is selected as the default for TC.
- 7) For customer-specific programming, for example mV and ohm, the start value and the end value of the required measuring span and the unit must be entered here.

Accessories

	Article No.
Additional accessories for assembly, connection and transmitter configuration, see page 2/251.	
Modems	
Modem with USB interface	7MF4997-1DB
Modem with USB interface and SIPROM T software	7NG3092-8KN
SIMATIC PDM parameterization software Also for SITRANS TH300	See section 8
Mounting bracket and fastening parts	
Made of steel for 7NG313-...B..	7MF4997-1AC
Made of steel for 7NG313-...C..	7MF4997-1AB
Made of stainless steel for 7NG313-...B..	7MF4997-1AJ
Made of stainless steel for 7NG313-...C..	7MF4997-1AH
Made of stainless steel 316L for 7NG313-...B..	7MF4997-1AQ
Made of stainless steel 316L for 7NG313-...C..	7MF4997-1AP
Digital display¹⁾	7MF4997-1BS
Connection board	A5E02226423

For supply units, see Catalog FI 01 section "Supplementary components".

¹⁾ Retrofitting not possible with Ex devices.

Ordering example 1

7NG3135-0AB11-Z Y01+Y23+U03

Y01: -10 ... +100 °C

Y23: TICA1234HEAT

Ordering example 2

7NG3136-0AC11-Z Y01+Y23+Y24+U25

Y01: -10 ... +100 °C

Y23: TICA 1234 ABC

Y24: HEATING BOILER 56789

Factory setting of the transmitter

- Pt100 (IEC 751); 3-wire connection
- Measuring range: 0 ... 100 °C (32 ... 212 °F)
- Fault current 22.8 mA
- Sensor offset: 0 °C (0 °F)
- Damping 0.0 s

Temperature measurement

Temperature transmitters

Field transmitters/field indicator

SITRANS TF - Transmitter, 2-wire system and SITRANS TF - Field indicator for 4 to 20 mA

	Article No.
SITRANS TF field indicator For 4 ... 20 mA signals	7NG3130 - ■ ■ ■ ■ ■
Click on the Article No. for the online configuration in the PIA Life Cycle Portal.	
Without Ex protection	0 1
With Ex ia (ATEX + IECEx)	1 1
With Ex nAL for Zone 2 (ATEX + IECEx)	2 1
Total device SITRANS TF Ex d (ATEX + IECEx) ¹⁾	4 1
Total device SITRANS TF according to FM (XP, DIP, NI, S) ¹⁾	5 1
Enclosure	
Die-cast aluminum	A
Stainless steel precision casting	E
Connections/cable inlet	
Screwed glands M20x1.5	B
½-14 NPT glands	C
Digital indicator	
With	1
Mounting bracket and fastening parts	
Without	0
Made of steel	1
Made of stainless steel	2

¹⁾ Without cable gland

Options	Order code
Append suffix "-Z" to article no., add order code and plain text, if applicable.	
Test report (5 measuring points)	C11
Explosion protection	
• Explosion protection Ex ia according to INMETRO (Brazil) (only for 7NG313.-1...)	E25¹⁾
• Explosion protection Ex d according to INMETRO (Brazil) (only for 7NG313.-4...)	E26¹⁾
• Explosion protection Ex nA according to INMETRO (Brazil) (only for 7NG313.-2...)	E27¹⁾
• Explosion protection Ex nA according to NEPSI (China) (only for 7NG313.-1...)	E55¹⁾
• Explosion protection Ex d according to NEPSI (China) (only for 7NG313.-4...)	E56¹⁾
• Explosion protection Ex nA according to NEPSI (China) (only for 7NG313.-2...)	E57¹⁾
• Explosion protection Ex d according to KOSHA (Korea) (only for 7NG313.-4...)	E70¹⁾
• Explosion protection Ex i according to EAC (Russia/Belarus/Kazakhstan) (only for 7NG313.-1...)	E81¹⁾
• Explosion protection Ex d according to EAC (Russia/Belarus/Kazakhstan) (only for 7NG313.-4...)	E82¹⁾
• Explosion protection Ex nA according to EAC (Russia/Belarus/Kazakhstan) (only for 7NG313.-2...)	E83¹⁾
Marine approvals	
• Det Norske Veritas Germanischer Lloyd (DNV GL)	D01
• Bureau Veritas (BV)	D02
• Lloyd's Register of Shipping (LR)	D04
• American Bureau of Shipping (ABS)	D05
Two-layer coating of enclosure and cover (PU on epoxy)	G10
Transient protection	J01
Cable gland CAPRI ½ NPT ADE 4F, nickel-plated brass (CAPRI 848694 and 810634) included	D57
Cable gland ½ NPT ADE 1F, cable diameter 6 ... 12 (CAPRI 818694 and 810534) included	D58

Options	Order code
Append suffix "-Z" to article no., add order code and plain text, if applicable.	
Cable gland ½ NPT ADE 4F, Stainless steel (CAPRI 848699 and 810634) included	D59
Cable gland ½ NPT ADE 1F, cable diameter 4 ... 8.5 (CAPRI 818674 and 810534) included	D60
Customer-specific programming	
Measuring range to be set	Y01²⁾
Specify in plain text (max. 5 digits): Y01:... to ... °C, °F	
Labeling of measuring point plate only, specify in plain text: Measuring range	Y22³⁾
Measuring point description, max. 16 characters	Y23³⁾
Measuring point description, max. 32 characters	Y24³⁾
Enter special deviating customer-specific setting in plain text	Y09⁴⁾
¹⁾ Option does not include ATEX/IECEx approval, only country-specific approval.	
²⁾ For customer-specific programming for RTD and TC, the start value and the end value of the required measuring span must be specified here.	
³⁾ If only Y22, Y23 or Y24 is ordered and if the labeling is <u>only</u> noted on the measuring point plate, do not specify Y01.	
⁴⁾ For customer-specific programming, for example mV and ohm, the start value and the end value of the required measuring span and the unit must be entered here.	
⁵⁾ Retrofitting not possible with Ex devices.	

Accessories

	Article No.
Additional accessories for assembly, connection and transmitter configuration, see page 2/251.	
Mounting bracket and fastening parts	
Made of steel for 7NG313.-.B..	7MF4997-1AC
Made of steel for 7NG313.-.C..	7MF4997-1AB
Made of stainless steel for 7NG313.-.B..	7MF4997-1AJ
Made of stainless steel for 7NG313.-.C..	7MF4997-1AH
Made of stainless steel 316L for 7NG313.-.B..	7MF4997-1AQ
Made of stainless steel 316L for 7NG313.-.C..	7MF4997-1AP
Digital display¹⁾	7MF4997-1BS
Connection board	A5E02226423
For supply units, see Catalog FI 01 section "Supplementary components".	

Ordering example 1

7NG3130-0AB10-Z Y01+Y23

Y01: -5 ... 100 °C

Y23: TICA1234HEAT

Ordering example 2

7NG3130-0AC11-Z Y01+Y23+Y24

Y01: 0 ... 20 BAR

Y23: PICA 1234 ABC

Y24: HEATING BOILER 67890

Factory setting of the display

4 ... 20 m

Dimensional drawings

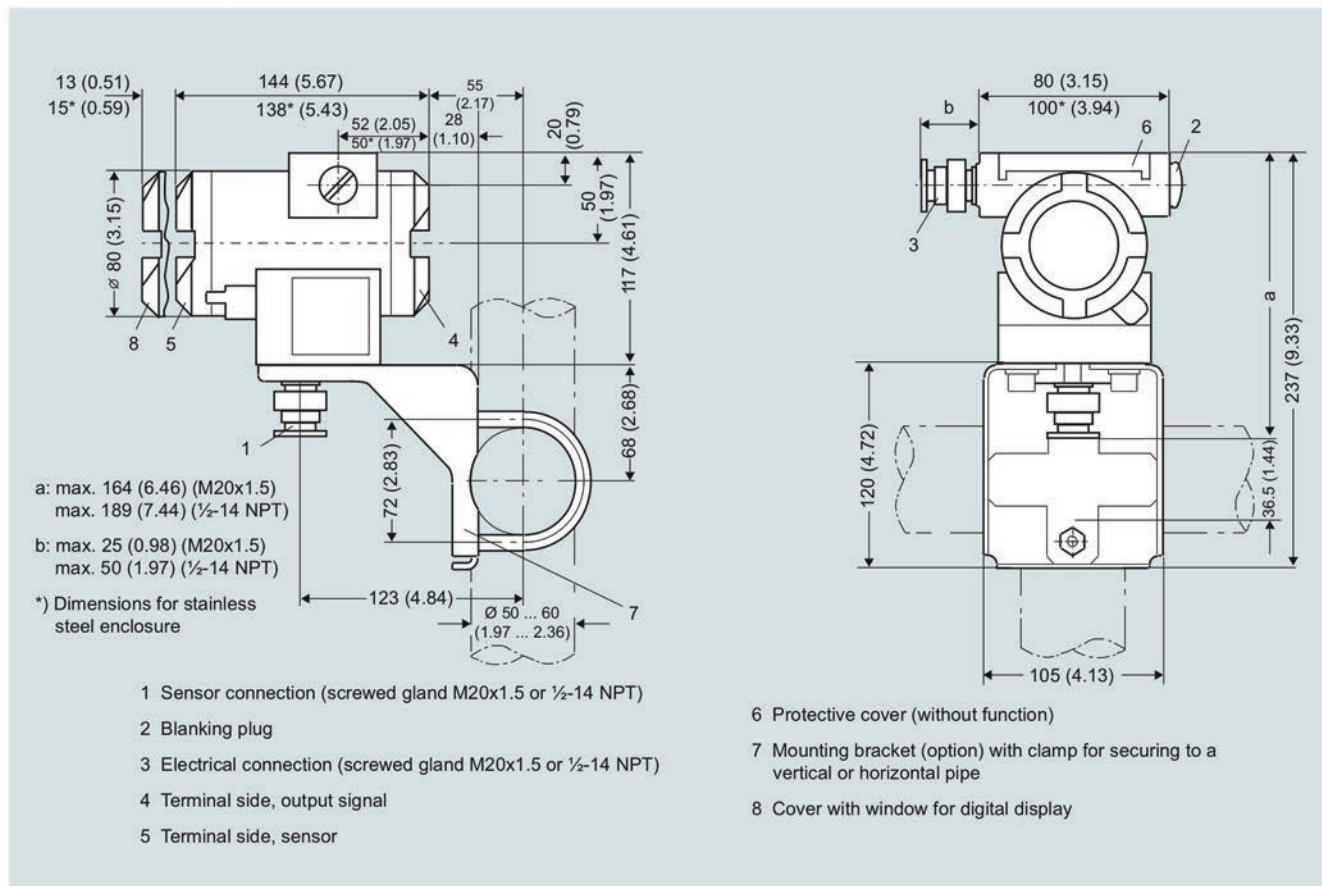

SITRANS TF, dimensions in mm (inches)

Temperature measurement

Temperature transmitters

Field transmitters/field indicator

SITRANS TF - Transmitter, 2-wire system and SITRANS TF - Field indicator for 4 to 20 mA

Circuit diagrams

Resistance thermometer

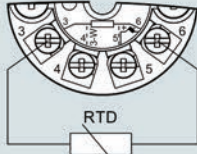

2-wire connection ¹⁾

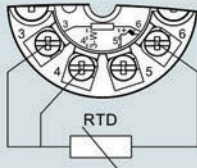

3-wire connection

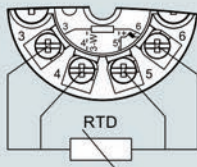

4-wire connection

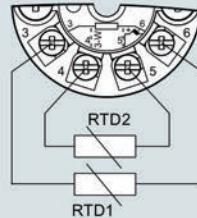

Generation of average value / difference ¹⁾

¹⁾ Programmable line resistance for the purpose of correction.

Resistance

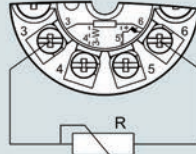

2-wire connection ¹⁾

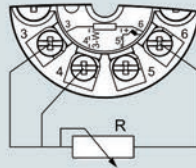

3-wire connection

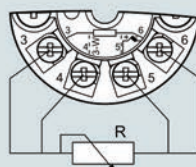

4-wire connection

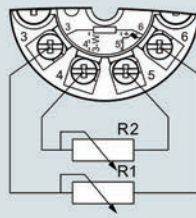

Generation of average value / difference ¹⁾

Thermocouple

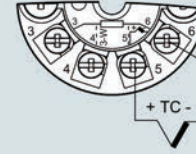

Cold junction compensation Internal/fixed value

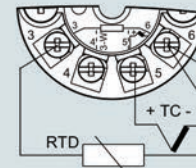

Cold junction compensation with external Pt100 in 2-wire connection ¹⁾

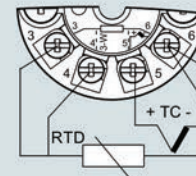

Cold junction compensation with external Pt100 in 3-wire connection

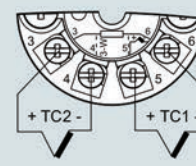

Generation of average value / difference with internal cold junction compensation

Voltage measurement

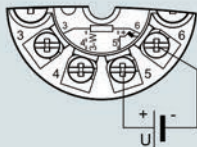

Current measurement

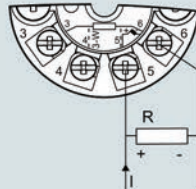

SITRANS TF, sensor connection assignment