

Parallel grippers DHPL

FESTO

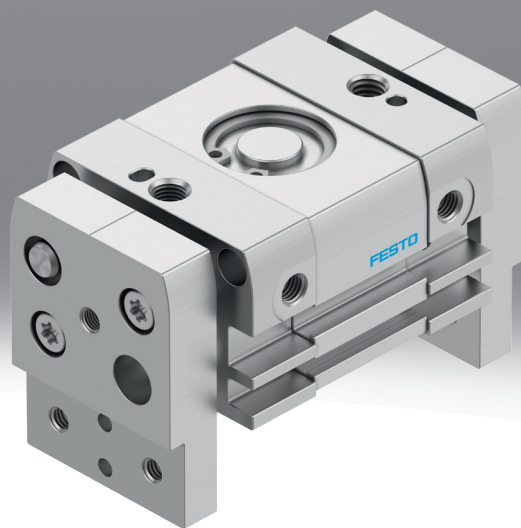

Characteristics

At a glance

[Further information → dhpl](#)

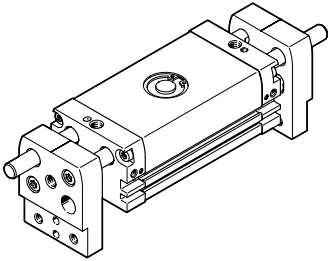

- Compact and sturdy design
- Ideal for gripping larger parts
- The grippers can absorb high torques thanks to the guided gripper jaws
- Double-acting piston drive
- Variable gripping direction: external and internal gripping
- Proximity switches are mounted via T-slot and C-slot

These grippers are not designed for the following or similar application examples:

- Machining
- Aggressive media
- Grinding dust
- Welding spatter

Engineering tools

[Further information → engineering tools](#)



Save time with engineering tools Smart Engineering for the optimal solution. Our goal is to increase your productivity. Our engineering tools play an integral part in this. They help you size your system correctly, tap into unimagined productivity reserves and generate additional productivity along the entire value chain. In every phase of your project, from the initial contact to the modernisation of your machine, you will come across a number of different tools which will be of use to you.

Gripper selection:

- This tool helps you to select the right grippers by simply entering the exact parameters for your application

Diagrams

[Further information → dhpl](#)



The diagrams shown in this document are also available online. These can be used to display precise values.

Cushioning

The drive is fitted with pneumatic end-position cushioning, which can be adapted by the operator for maximum performance according to the moving mass and speed.

Position sensing

By using proximity switches, any position can be detected.

Type code

001	Series
DHPL	Parallel gripper

002	Size [mm]
10	10
16	16
20	20
25	25
32	32
40	40

003	Complete stroke [mm]
20	20
30	30
40	40
50	50
60	60
70	70
80	80
100	100
120	120
160	160
200	200

004	Cushioning
P	Elastic cushioning rings/plates on both sides

005	Position sensing
A	For proximity sensor

Datasheet

General technical data												
Size	10		16		20		25		32		40	
Total stroke	20 mm	60 mm	30 mm	80 mm	40 mm	100 mm	50 mm	120 mm	70 mm	160 mm	100 mm	200 mm
Stroke per gripper jaws	10 mm	30 mm	15 mm	40 mm	20 mm	50 mm	25 mm	60 mm	35 mm	80 mm	50 mm	100 mm
Design	Rack and pinion											
Mode of operation	Double-acting											
Guide	Plain-bearing guide											
Gripper function	Parallel											
Cushioning	Elastic cushioning rings/plates at both ends											
Number of gripper jaws	2											
Max. mass per external gripper finger ¹⁾	54 g		93 g		170 g		305 g		498 g		801 g	
Pneumatic connection	M5								G1/8			
Repetition accuracy, gripper ²⁾	≤0.03 mm											
Rotationally symmetrical	≤0.2 mm											
Max. replacement accuracy	≤0.2 mm											
Max. operating frequency of gripper	≤2 Hz	≤1.5 Hz	≤2 Hz	≤1.5 Hz	≤2 Hz	≤1.5 Hz	≤2 Hz	≤1.5 Hz	≤1 Hz	≤0.6 Hz	≤1 Hz	≤0.6 Hz
Position detection	Via proximity switch											
Type of mounting	Either: With through-hole		Either: Direct mounting via thread With through-hole									
Mounting position	optional											

1) Applies to unthrottled operation

2) Under constant exposure to operating conditions, end-position drift occurs in the direction of movement of the gripper jaws at 100 consecutive strokes

Operating and environmental conditions												
Size	10		16		20		25		32		40	
Operating pressure ¹⁾	0.25 ... 0.8 MPa		0.15 ... 0.8 MPa									
Operating pressure ²⁾	36.25 ... 116 psi		21.75 ... 116 psi									
Operating pressure ³⁾	2.5 ... 8 bar		1.5 ... 8 bar									
Operating medium	Compressed air to ISO 8573-1:2010 [7:4:4]											
Note on operating and pilot medium	Lubricated operation possible (in which case lubricated operation will always be required)											
Ambient temperature ⁴⁾	-10 ... 60°C											
Maintenance interval	Life-time lubrication											
Corrosion resistance class CRC ⁵⁾	1 - Low corrosion stress											

1) DHPL-10: After a longer period of downtime, the min. operating pressure 0.25 MPa (2.5 bar, 36 psi) can increase to 0.4 MPa (4 bar, 58 psi).

2) DHPL-10: After a longer period of downtime, the min. operating pressure 0.25 MPa (2.5 bar, 36 psi) can increase to 0.4 MPa (4 bar, 58 psi).

3) DHPL-10: After a longer period of downtime, the min. operating pressure 0.25 MPa (2.5 bar, 36 psi) can increase to 0.4 MPa (4 bar, 58 psi).

4) Note the operating range of the proximity switches

5) More information: www.festo.com/x/topic/crc

Weight												
Size	10		16		20		25		32		40	
Total stroke	20 mm	60 mm	30 mm	80 mm	40 mm	100 mm	50 mm	120 mm	70 mm	160 mm	100 mm	200 mm
Product weight	251 g	377 g	499 g	802 g	883 g	1,407 g	1,447 g	2,297 g	2,634 g	4,154 g	4,480 g	6,480 g

Datasheet

Materials

Size	10	16	20	25	32	40
Material o-ring	NBR					
Material housing	Anodised wrought aluminium alloy					
Material cover	Anodised wrought aluminium alloy					
Material cover cap	Wrought aluminium alloy, anodised					
Material end plate	Anodised wrought aluminium alloy					
Material gripper jaws	Anodised wrought aluminium alloy					
Material piston rod	High-alloy stainless steel					
Material piston seal	TPE-U(PU)					
Gear rack material	High-alloy stainless steel					
Material screws	Galvanised steel					
Note on materials	RoHS-compliant					

Measured gripping force with a lever arm of 20 mm

Size	10		16		20		25		32		40	
Total stroke	20 mm	60 mm	30 mm	80 mm	40 mm	100 mm	50 mm	120 mm	70 mm	160 mm	100 mm	200 mm
Total gripping force, closing, 0.6MPa (6bar, 87 psi)	38 N	44 N	130 N	142 N	230 N	238 N	360 N	380 N	570 N	600 N	924 N	992 N
Total gripping force, opening, 0.6MPa (6bar, 87 psi)	60 N	68 N	180 N	190 N	310 N	316 N	470 N	490 N	760 N	800 N	1,100 N	1,180 N
Gripper force per gripper jaw, closing, 0.6 MPa (6 bar, 87 psi)	19 N	22 N	65 N	71 N	115 N	119 N	180 N	190 N	285 N	300 N	462 N	496 N
Gripper force per gripper jaw, opening, 0.6 MPa (6 bar, 87 psi)	30 N	34 N	90 N	95 N	155 N	158 N	235 N	245 N	380 N	400 N	550 N	590 N

Characteristic load values at the gripper jaws

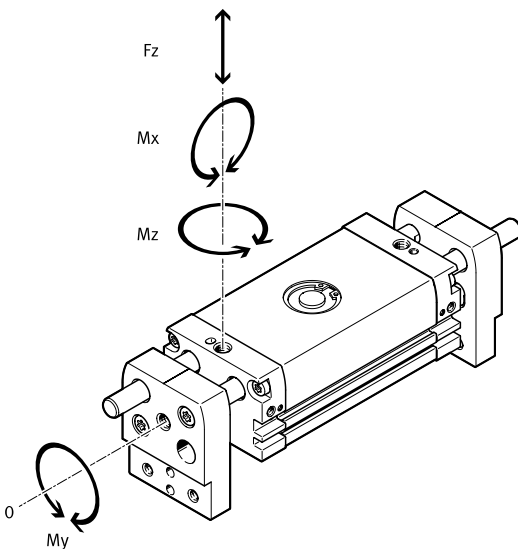

The indicated permissible forces and torques apply to a single gripper jaw. They include the lever arm, additional applied loads created by the workpiece or external gripper fingers and acceleration forces occurring during movement. The zero coordinate line (gripper jaw guide) must be taken into account when calculating torques.

Size	10	16	20	25	32	40
Max. force on gripper jaw F_z static	40 N	240 N	280 N	320 N	750 N	
Max. torque at gripper M_x static	0.5 Nm	3.5 Nm	5 Nm	6.5 Nm	18 Nm	22 Nm
Max. torque at gripper M_y static	0.5 Nm	3.5 Nm	5 Nm	6.5 Nm	18 Nm	22 Nm
Max. torque at gripper M_z static	0.5 Nm	3.5 Nm	5 Nm	6.5 Nm	18 Nm	22 Nm

Datasheet

Gripping force F per gripper jaw as a function of operating pressure and lever arm x – external gripping (closing)

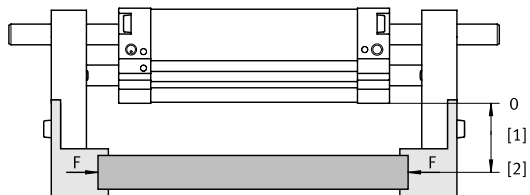

The gripping forces as a function of the operating pressure and lever arm can be determined from the following graphs.
The gripping torque is not constant across the opening angle.

Engineering software for gripper selection → www.festo.com

- [1] Lever arm x
- [2] Load point

Gripping force F per gripper jaw as a function of operating pressure and lever arm x – External gripping (closing), double-acting – DHPL-10-20-...-A

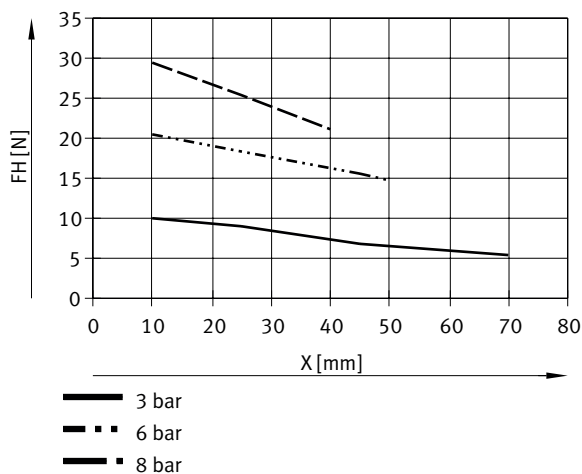

Gripping force F per gripper jaw as a function of operating pressure and lever arm x – External gripping (closing), double-acting – DHPL-10-60-...-A

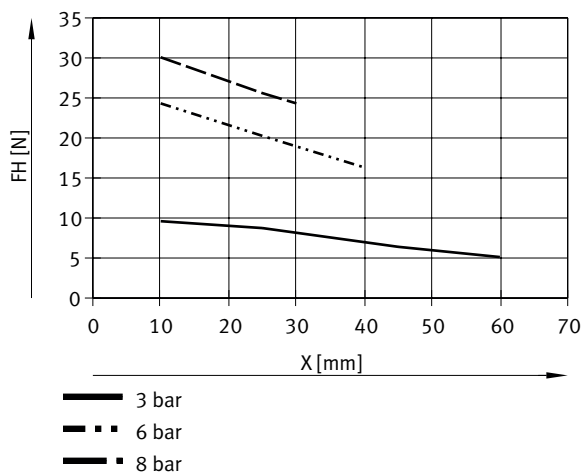

Datasheet

Gripping force F per gripper jaw as a function of operating pressure and lever arm x – External gripping (closing), double-acting – DHPL-16-30-...-A

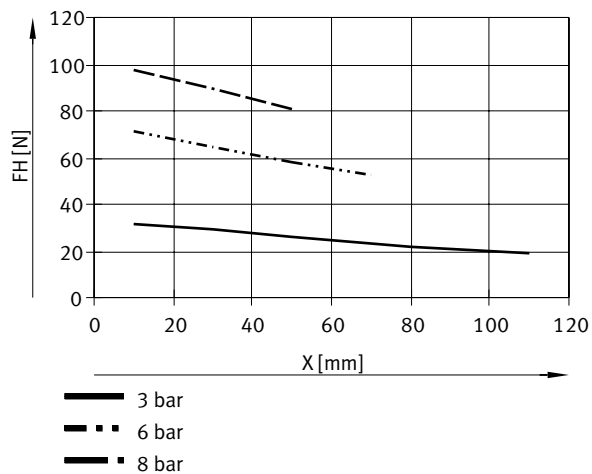

Gripping force F per gripper jaw as a function of operating pressure and lever arm x – External gripping (closing), double-acting – DHPL-16-80-...-A

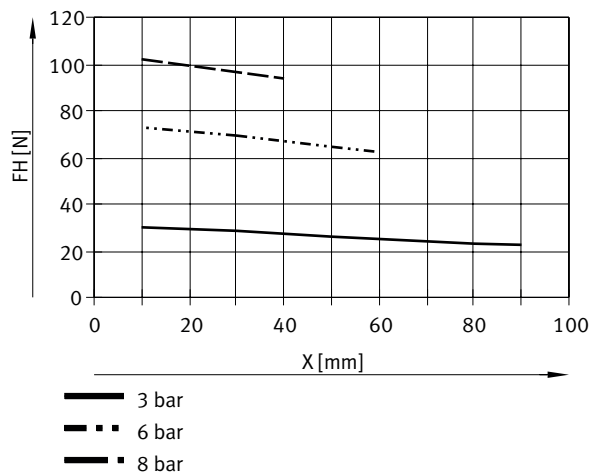

Gripping force F per gripper jaw as a function of operating pressure and lever arm x – External gripping (closing), double-acting – DHPL-20-40-...-A

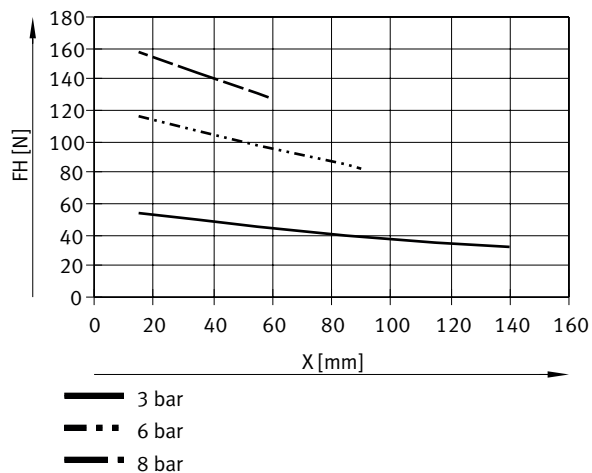

Datasheet

Gripping force F per gripper jaw as a function of operating pressure and lever arm x – External gripping (closing), double-acting – DHPL-20-100-...-A

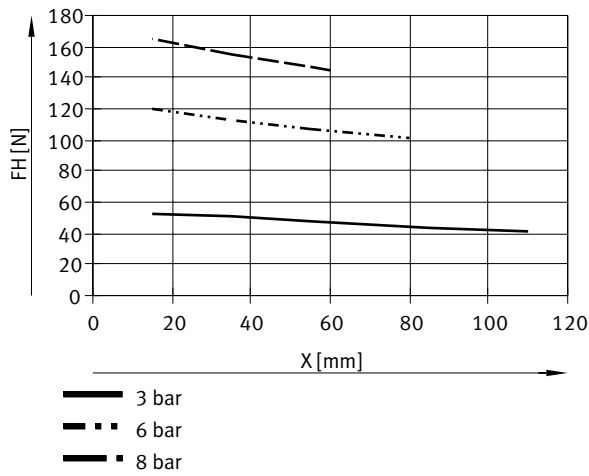

Gripping force F per gripper jaw as a function of operating pressure and lever arm x – External gripping (closing), double-acting – DHPL-25-50-...-A

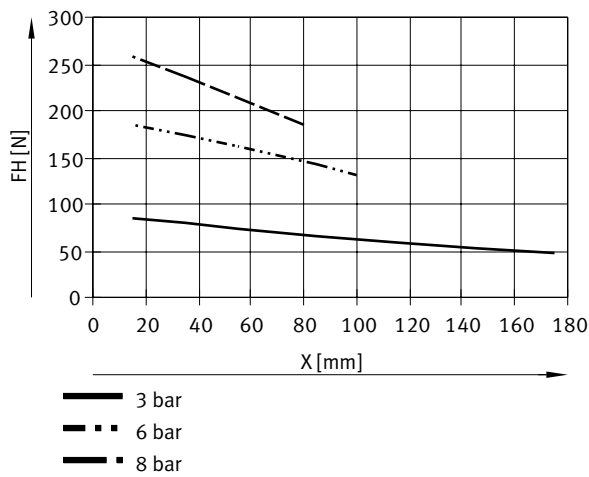

Gripping force F per gripper jaw as a function of operating pressure and lever arm x – External gripping (closing), double-acting – DHPL-25-120-...-A

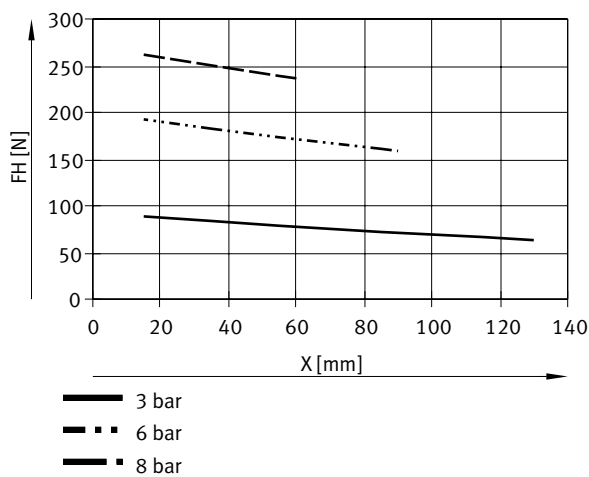

Datasheet

Gripping force F per gripper jaw as a function of operating pressure and lever arm x – External gripping (closing), double-acting – DHPL-32-70-...-A

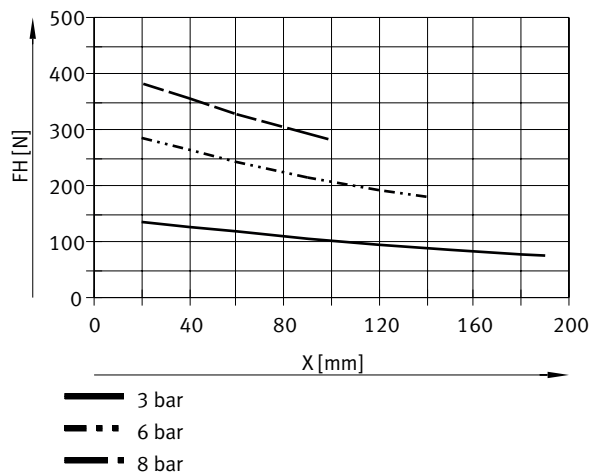

Gripping force F per gripper jaw as a function of operating pressure and lever arm x – External gripping (closing), double-acting – DHPL-32-160-...-A

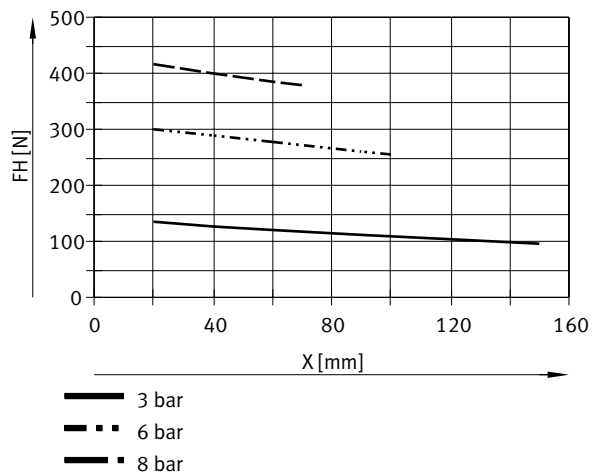

Gripping force F per gripper jaw as a function of operating pressure and lever arm x – External gripping (closing), double-acting – DHPL-40-100-...-A

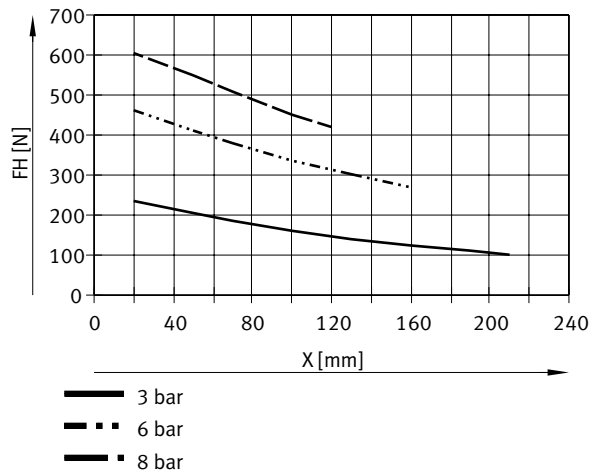

Datasheet

Gripping force F per gripper jaw as a function of operating pressure and lever arm x – External gripping (closing), double-acting – DHPL-40-200-...-A

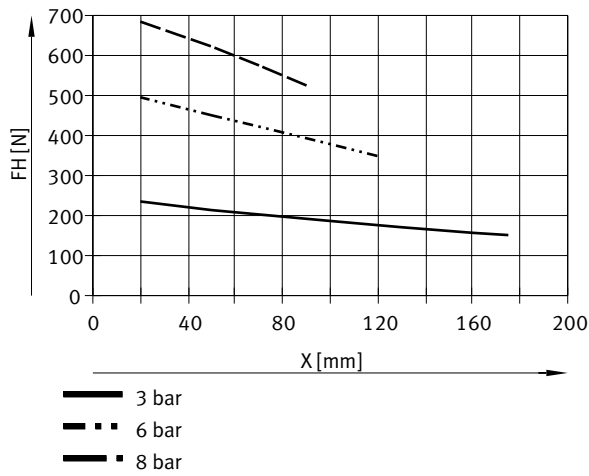

Gripping force F per gripper jaw as a function of operating pressure and lever arm x – internal gripping (opening)

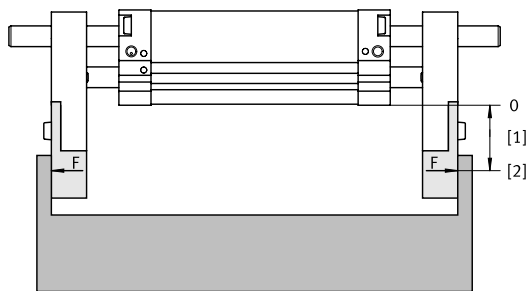

The gripping forces as a function of the operating pressure and lever arm can be determined from the following graphs.

The gripping torque is not constant across the opening angle.

Engineering software for gripper selection → www.festo.com

[1] Lever arm x

[2] Load point

Gripping force F per gripper jaw as a function of operating pressure and lever arm x – Internal gripping (opening), double-acting – DHPL-10-20-...-A

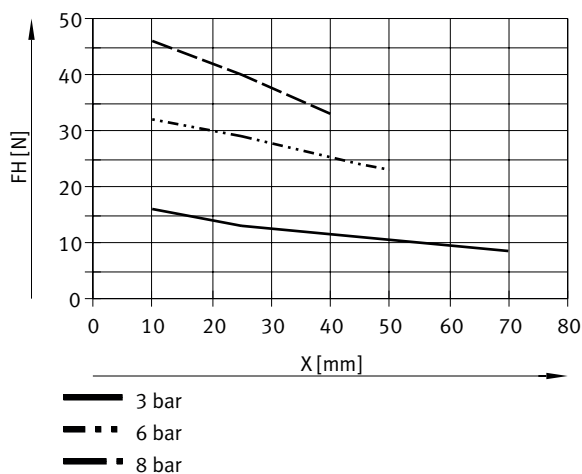

Datasheet

Gripping force F per gripper jaw as a function of operating pressure and lever arm x – Internal gripping (opening), double-acting – DHPL-10-60-...-A

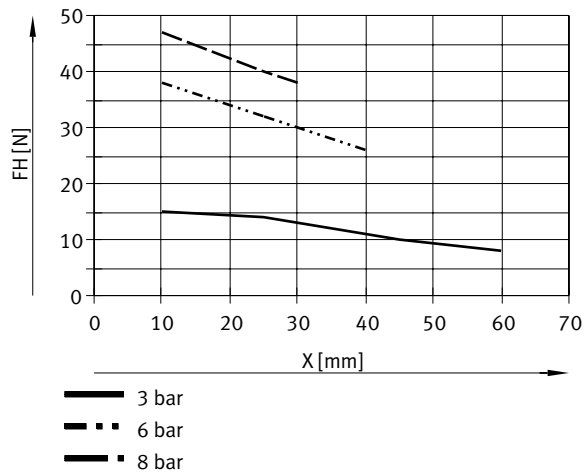

Gripping force F per gripper jaw as a function of operating pressure and lever arm x – Internal gripping (opening), double-acting – DHPL-16-30-...-A

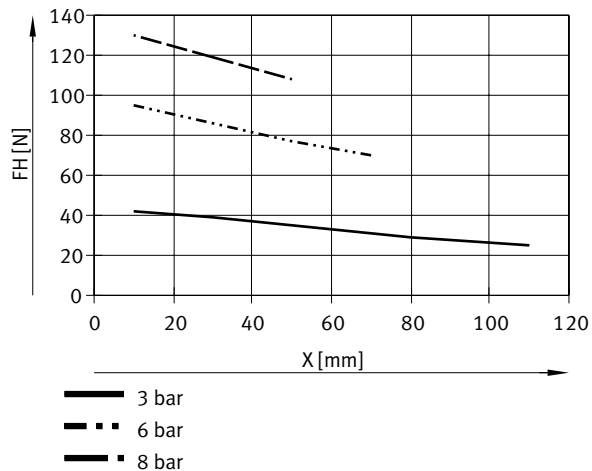

Gripping force F per gripper jaw as a function of operating pressure and lever arm x – Internal gripping (opening), double-acting – DHPL-16-80-...-A

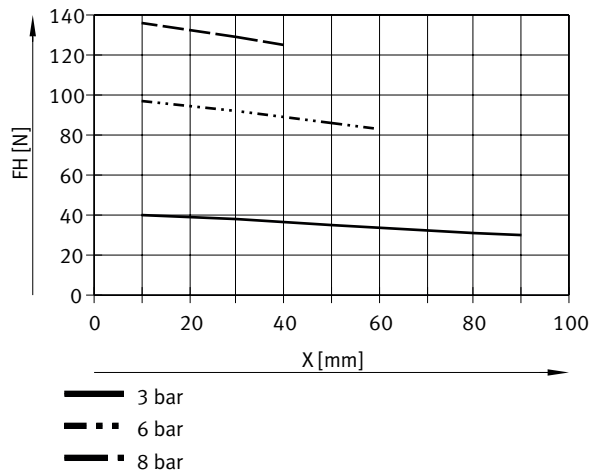

Datasheet

Gripping force F per gripper jaw as a function of operating pressure and lever arm x – Internal gripping (opening), double-acting – DHPL-20-40-...-A

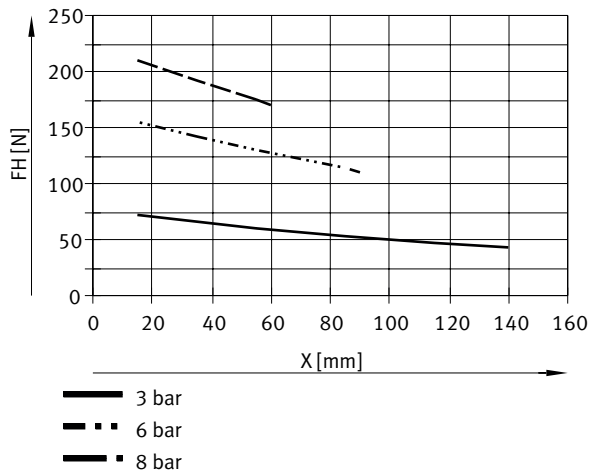

Gripping force F per gripper jaw as a function of operating pressure and lever arm x – Internal gripping (opening), double-acting – DHPL-20-100-...-A

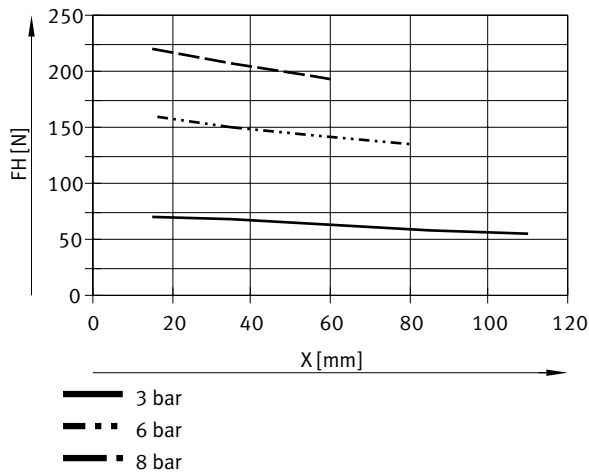

Gripping force F per gripper jaw as a function of operating pressure and lever arm x – Internal gripping (opening), double-acting – DHPL-25-50-...-A

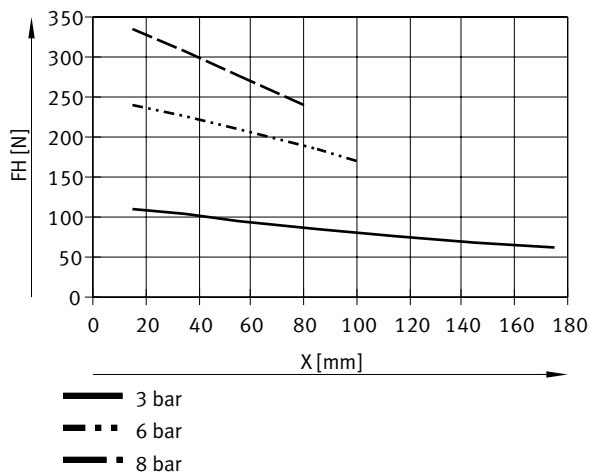

Datasheet

Gripping force F per gripper jaw as a function of operating pressure and lever arm x – Internal gripping (opening), double-acting – DHPL-25-120-...-A

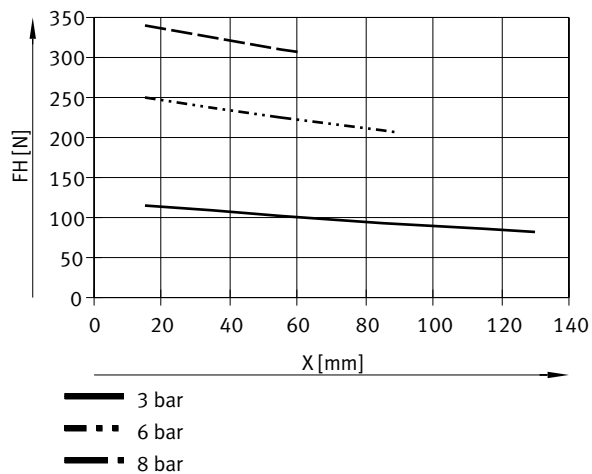

Gripping force F per gripper jaw as a function of operating pressure and lever arm x – Internal gripping (opening), double-acting – DHPL-32-70-...-A

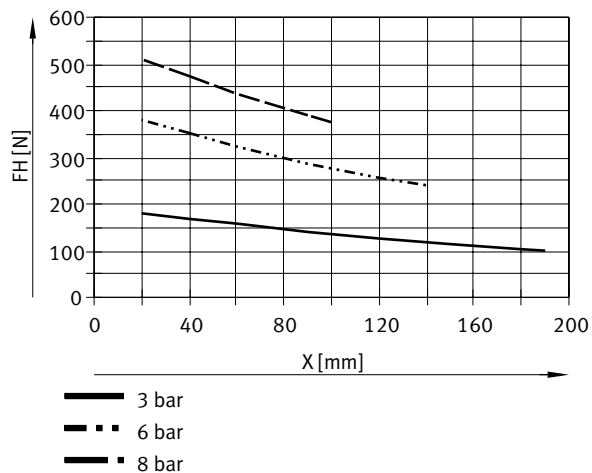

Gripping force F per gripper jaw as a function of operating pressure and lever arm x – Internal gripping (opening), double-acting – DHPL-32-160-...-A

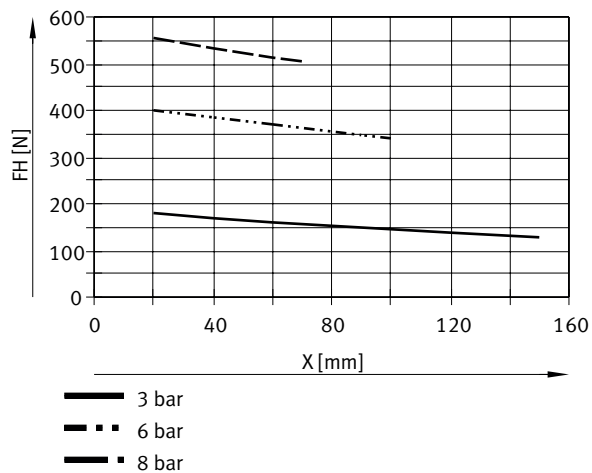

Datasheet

Gripping force F per gripper jaw as a function of operating pressure and lever arm x – Internal gripping (opening), double-acting – DHPL-40-100-...-A

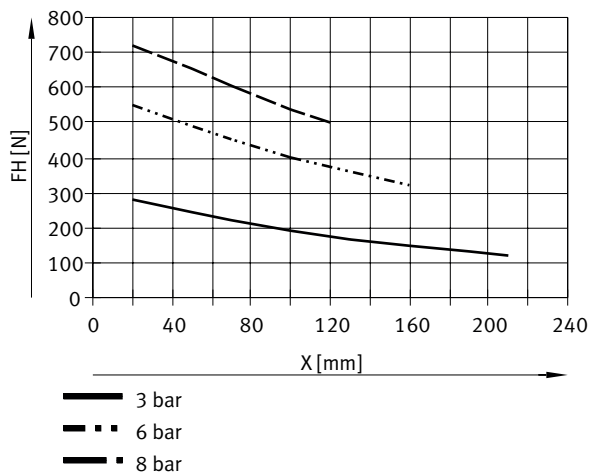

Gripping force F per gripper jaw as a function of operating pressure and lever arm x – Internal gripping (opening), double-acting – DHPL-40-200-...-A

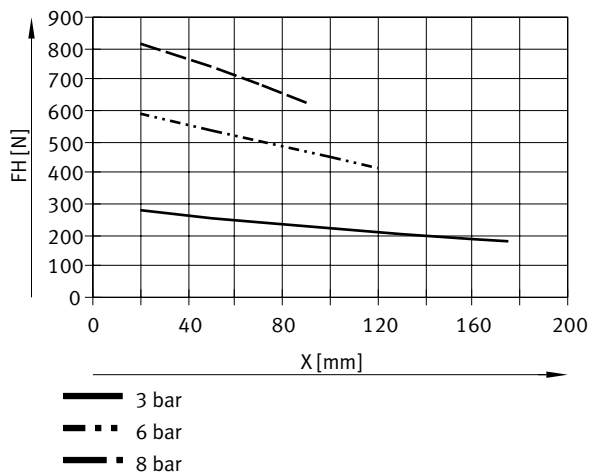

Gripping force F per gripper jaw at 0.6 MPa (6 bar, 87 psi) as a function of lever arm x and eccentricity a and b

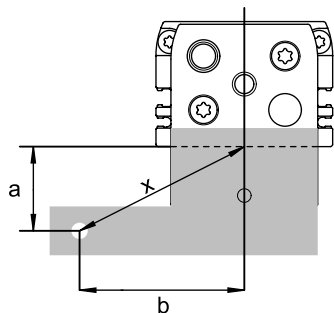

Datasheet

Gripping force F per gripper jaw at 0.6 MPa (6 bar, 87 psi) as a function of lever arm x and eccentricity a and b

$$x = \sqrt{a^2 + b^2} = \sqrt{40^2 + 45^2} = 60 \text{ mm}$$

The formula (on the left) must be used to calculate the lever arm x with eccentric gripping.

The gripping force F can then be read from the graphs using the calculated value x.

Calculation example:

Assuming:

Distance a = 40 mm

Distance b = 45 mm

To be determined:

The gripping force at 6 bar, with a DHPL-25-50-P-A used as an external gripper.

Gripping force F per gripper jaw at 0.6 MPa (6 bar, 87 psi) as a function of lever arm x and eccentricity a and b

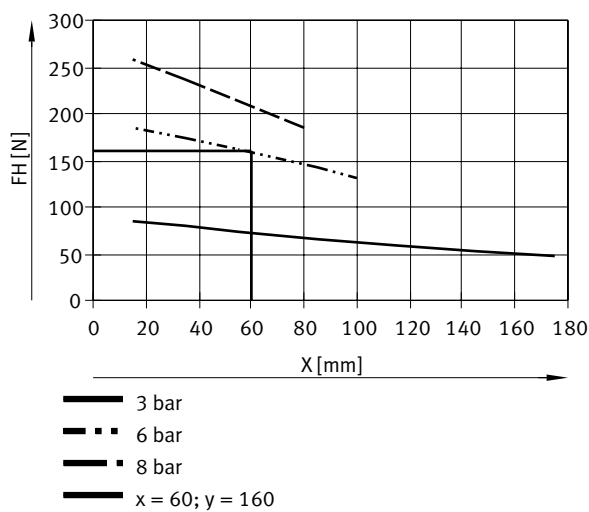

The graph gives a value of F = 160 N for the gripping force.

Mass moments of inertia

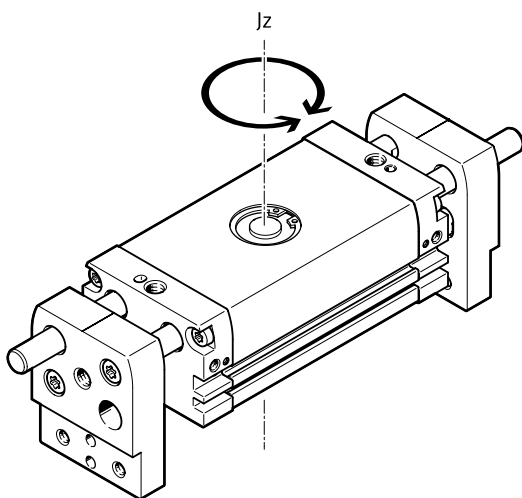

Mass moment of inertia of the parallel grippers in relation to the central axis, without external gripper fingers, with no load.

Mass moments of inertia – Gripper closed; gripper open

Size	10		16		20	
Total stroke	20 mm		60 mm		100 mm	
Mass moment of inertia	1.6 kgcm ² ; 2.2 kgcm ²		4.8 kgcm ² ; 9.6 kgcm ²		4.3 kgcm ² ; 6.6 kgcm ²	
					9.7 kgcm ² ; 12.6 kgcm ²	
					15.4 kgcm ² ; 23.5 kgcm ²	
					49.3 kgcm ² ; 104.5 kgcm ²	

Datasheet

Mass moments of inertia – Gripper closed; gripper open

Size	25		32		40	
Total stroke	50 mm	120 mm	70 mm	160 mm	100 mm	200 mm
Mass moment of inertia	50.4 kgcm ² ; 76.4 kgcm ²	118.1 kgcm ² ; 258.9 kgcm ²	101.8 kgcm ² ; 176.1 kgcm ²	315.8 kgcm ² ; 727 kgcm ²	249.5 kgcm ² ; 487.2 kgcm ²	786.9 kgcm ² ; 1,625 kgcm ²

Gripper jaw backlash

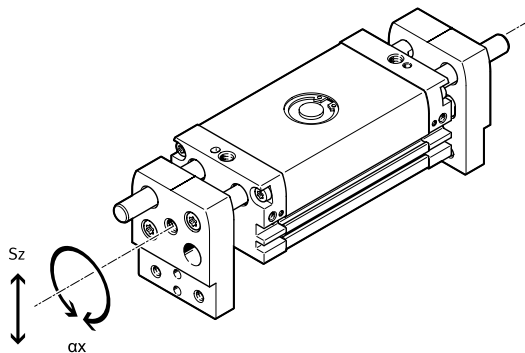

The plain-bearing guide used in the grippers means that there is backlash between the gripper jaws and the housing. The values listed in the table apply in new condition.

Size	10	16	20	25	32	40
Max. gripper jaw backlash Sz ¹⁾	≤0.064 mm	≤0.072 mm	≤0.068 mm	≤0.064 mm	≤0.066 mm	≤0.065 mm
Max. angular gripper jaw backlash ax, ay ²⁾	≤0.22 deg	≤0.15 deg	≤0.14 deg	≤0.13 deg	≤0.12 deg	≤0.1 deg

1) The values only apply when the gripper is open.

2) The values only apply when the gripper is open.

Opening and closing times

Size	10		16		20		25		32		40	
	20 mm	60 mm	30 mm	80 mm	40 mm	100 mm	50 mm	120 mm	70 mm	160 mm	100 mm	200 mm
Min. opening time at 0.6 MPa (6 bar, 87 psi) ¹⁾	41 ms	110 ms	53 ms	157 ms	71 ms	189 ms	81 ms	201 ms	112 ms	272 ms	220 ms	427 ms
Min. closing time at 0.6 MPa (6 bar, 87 psi) ²⁾	70 ms	174 ms	75 ms	221 ms	108 ms	274 ms	116 ms	274 ms	209 ms	473 ms	281 ms	524 ms

1) The indicated opening and closing times [ms] were measured at room temperature at an operating pressure of 0.6 MPa (6 bar, 87 psi) with a horizontally mounted gripper without additional gripper fingers.

The grippers must be throttled for larger loads [g]. Opening and closing times must then be adjusted accordingly.

2) The indicated opening and closing times [ms] were measured at room temperature at an operating pressure of 0.6 MPa (6 bar, 87 psi) with a horizontally mounted gripper without additional gripper fingers.

The grippers must be throttled for larger loads [g]. Opening and closing times must then be adjusted accordingly.

Dimensions

	L ¹⁾	B1 ±0,2	B2	B3	B4 ±0,25	B5 ±0,15	B6	B7 ±0,1	D1 ∅	D2 ∅	D3	D4 ∅ H9	D5	D6 ∅ H13	D8 H9	D9
DHPL-10	20	44	20	18	34	20	6	6	6	6	M6	3	M4	4,5	3	M4x0,5
	60															
DHPL-16	30	55	22	23	43	25	9	9	8	8	M8	4	M5	5,5		M6x0,5
	80															
DHPL-20	40	65	30	30	54	30	8	8	10	10		5	M6	6,5	4	M8x1
	100															

	L ¹⁾	D10	EE	H1 ±0,35	H2 ±0,25	H3 ±0,7	H4	H5	H6	H7	H8	H9 ±0,35	H10 ±0,15	H11 ±0,15	H12 ±0,05	H13 ±0,15
DHPL-10	20	M4	M5	11,5	15,5	46,5	18	8	12,5	9	46	10	34,5	38,5	8	15
	60															
DHPL-16	30	M5		16	19,5	58,5	24		17,5	10	58	16,5	44,5	49,5	10	20
	80															
DHPL-20	40	M6	19	22	68	28	9	19,8	11,7	67	20	53	59	22		
	100															

	L ¹⁾	H14	L1		L2 ±0,1	L3 ±0,25	L4 ±0,25	L5 ±1	L6 ±0,25	L7 ±0,25	L8 ±0,05	L9	T1 ±0,2	T4	T5	T6
			2)	3)												
			±1,5													
DHPL-10	20	0,5	56	76	10	42,2	33	77	51	42	7	1	4	12	3,5	5
	60		96	156		76,2	67	151	85	76						
DHPL-16	30		68	98	13	47	45	96	60	48	9		3	16	6	7
	80	130	210	97		95	196	110	98							
DHPL-20	40	1	82	122	17	53	59	117	71	58	12,5	4,5	7			
	100		162	262		113	119	237	131	118						

- 1) Stroke
- 2) Gripper closed
- 3) Gripper open

Dimensions

Dimensions – DHPL-25 ... 40

Download CAD data → www.festo.com

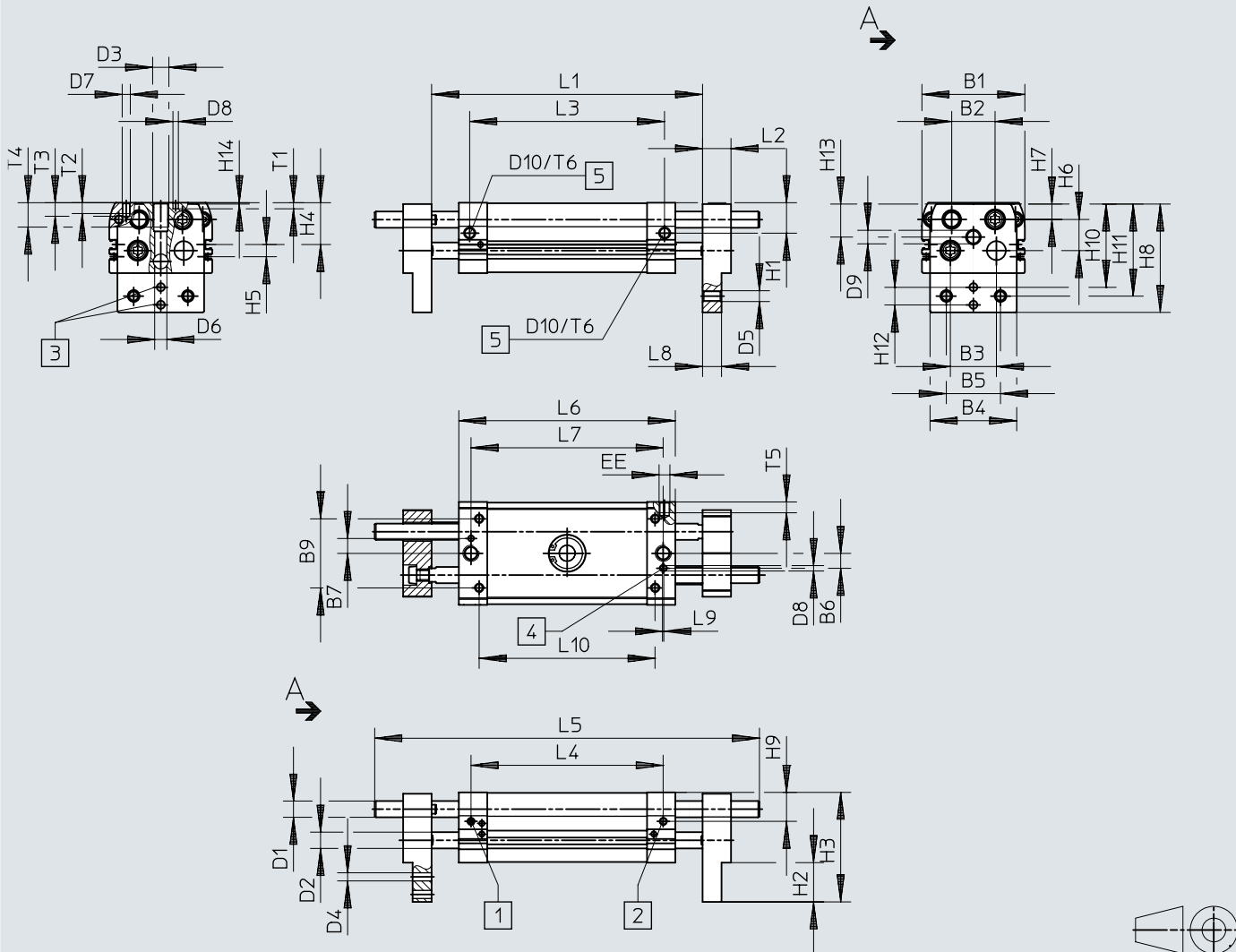

- [1] Close compressed air supply port
- [2] Open compressed air supply port
- [3] Centring holes
- [4] Centring hole, slot
- [5] Thread for mounting the gripper from the rear

Dimensions

	L ¹⁾	B1 ±0,2	B2	B3	B4 ±0,25	B5 ±0,15	B6	B7 ±0,1	B9 ±0,1	D1 ∅	D2 ∅	D3	D4 ∅ H9	D5	D6 ∅ H13	D7	D8 H9	D9
DHPL-25	50	76	32	34	64	40	11	11	51	12	12	M12	6	M8	9	M6	4	M10x1
	120																	
DHPL-32	70	82	32	37	70	50	12	12	60	16	16	M12	9	M10	10	M8	6	M12x1
	160																	
DHPL-40	100	98	44	45	86	60	12	12	76	16	16	-	10	M12	11	M10	6	M14x1
	200																	

	L ¹⁾	D10	EE	H1 ±0,35	H2 ±0,25	H3 ±0,7	H4	H5	H6	H7	H8	H9 ±0,35	H10 ±0,15	H11 ±0,15	H12 ±0,05	H13 ±0,15	H14	L2 ±0,1
DHPL-25	50	M8	M5	22,5	29	81	30,9	9	22,9	11,5	80	21,5	61,5	68	13	24,4	1	21
	120																	
DHPL-32	70	M8	G1/8	25	32	100	34,5	24	31	14,5	99	24,5	76,5	84	15	30	1	24
	160																	
DHPL-40	100	M10	G1/8	30,5	38	117	41,5	26	37	16,5	116	30,5	87	98	20	34	1	28
	200																	

	L ¹⁾	L1		L3 ±0,25	L4 ±0,25	L5 ±1	L6 ±0,25	L7 ±0,25	L8 ±0,05	L9	L10 ±0,15	T1 ±0,2	T2	T3	T4	T5	T6
		2)	3)														
		±1,5															
DHPL-25	50	100	150	72	70	142	88	70	14	1	58	4,5	8	10	18	6	8
	120	200	320								144						
DHPL-32	70	150	220	88	86	186	110	86	15	1	86	6	16	18	24	10	11
	160	242	402								178						
DHPL-40	100	188	288	118	118	254	148	116	18	1	116	8	20	23	79	10	15
	200	286	486								216						

- 1) Stroke
- 2) Gripper closed
- 3) Gripper open

Dimensions

Dimensions – Mounting bracket HAMF-MA

Download CAD data → www.festo.com

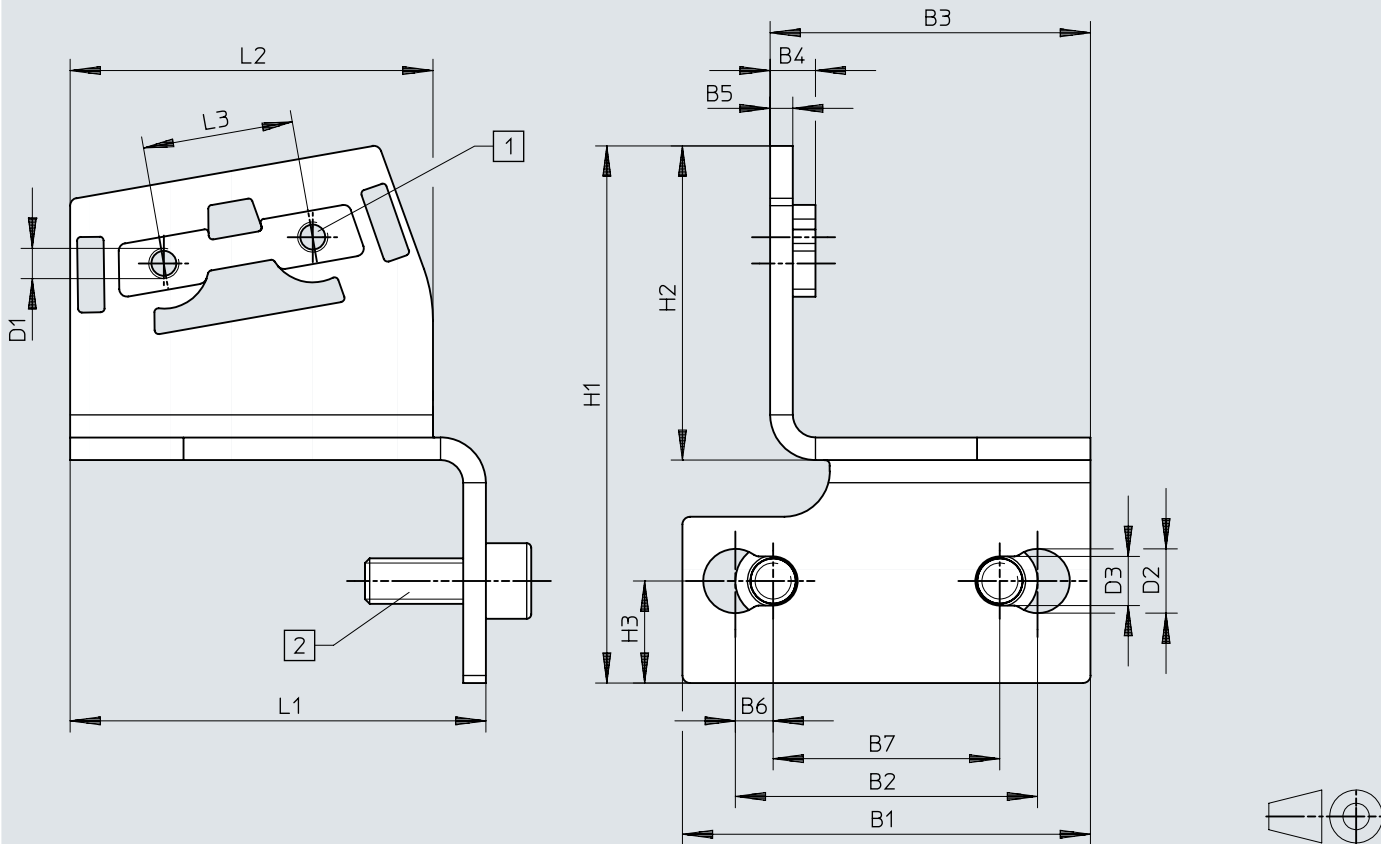

- [1] Mounting thread
- [2] HAMF-MA-...S1: screw M6x16 / HAMF-MA-...S2: screw M8x16 (included in the scope of delivery)

	B1	B2	B3	B4	B5	B6	B7	D1
HAMF-MA-B27-60-S1	54	40	39	6	3	5	30	M3
HAMF-MA-B27-80-S1			40,6					M4
HAMF-MA-B27-120-S1			42,4					M3
HAMF-MA-B27-60-S2			39					M4
HAMF-MA-B27-80-S2			40,6					
HAMF-MA-B27-120-S2			42,4					

	D2	D3	H1	H2	H3	L1	L2	L3
HAMF-MA-B27-60-S1	8,5	6,5	59,8	30,3	13,5	33	25,7	7
HAMF-MA-B27-80-S1			64,4	34,9		41,5	34,5	12
HAMF-MA-B27-120-S1			71,1	41,6		55	48	20
HAMF-MA-B27-60-S2			59,8	30,3		33	25,7	7
HAMF-MA-B27-80-S2			64,4	34,9		41,5	34,5	12
HAMF-MA-B27-120-S2			71,1	41,6		55	48	20

Dimensions

Dimensions – Adaptive gripper finger DHAS-GF

Download CAD data → www.festo.com

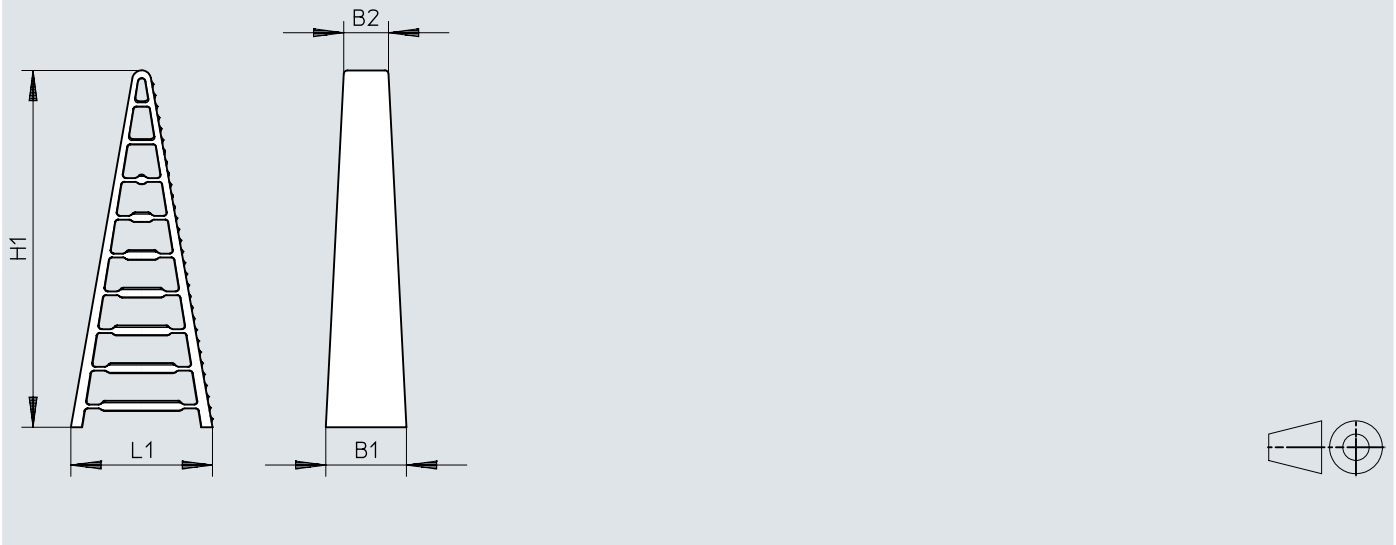

	B1	B2	H1	L1
DHAS-GF-60-U-BU	18	11,8	61,5	26
DHAS-GF-80-U-BU	21,3	11,8	94,5	37,5
DHAS-GF-120-U-BU	25	11,8	134,5	50

Dimensions

Dimensions – Mounting kit DHAS-ME-H9-60/80

Download CAD data → www.festo.com

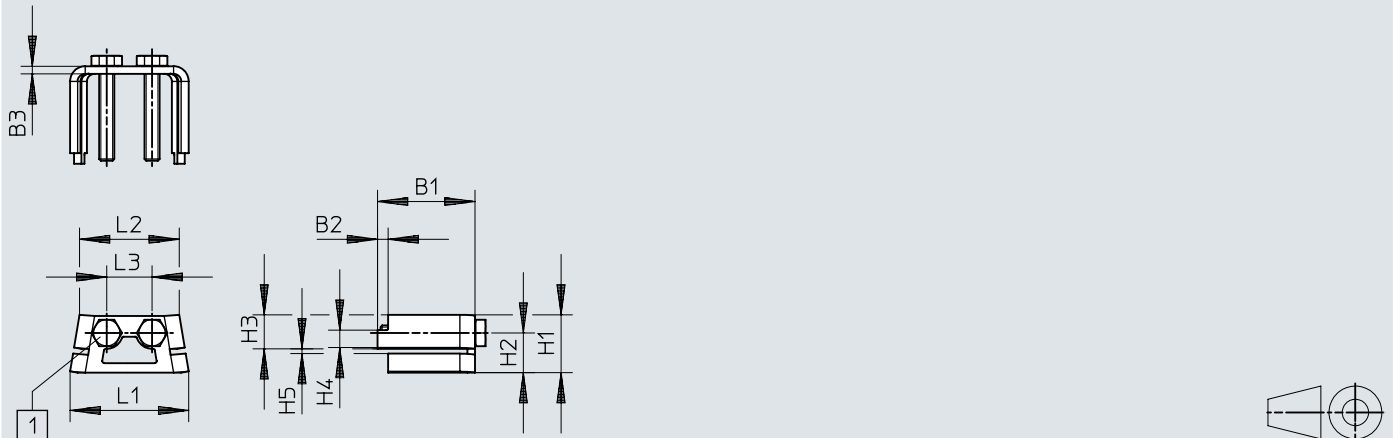

[1] DHAS-ME-H9-60: ISO 4017-M3x22-A2-70 screw / DHAS-ME-H9-80: ISO 4017-M4x25-A2-70 screw

	B1	B2	B3	H1	H2	H3	H4	H5	L1	L2	L3
			±0,1					±0,1			±0,1
DHAS-ME-H9-60	22,8	2,8	2	10,3	6,7	7	3,6	1,3	20,7	17,4	7
DHAS-ME-H9-80	25,8	2,8	2	15,3	10,5	9	4,6	1,3	31,4	26,4	12

Dimensions

Dimensions – Mounting kit DHAS-ME-H9-120

Download CAD data → www.festo.com

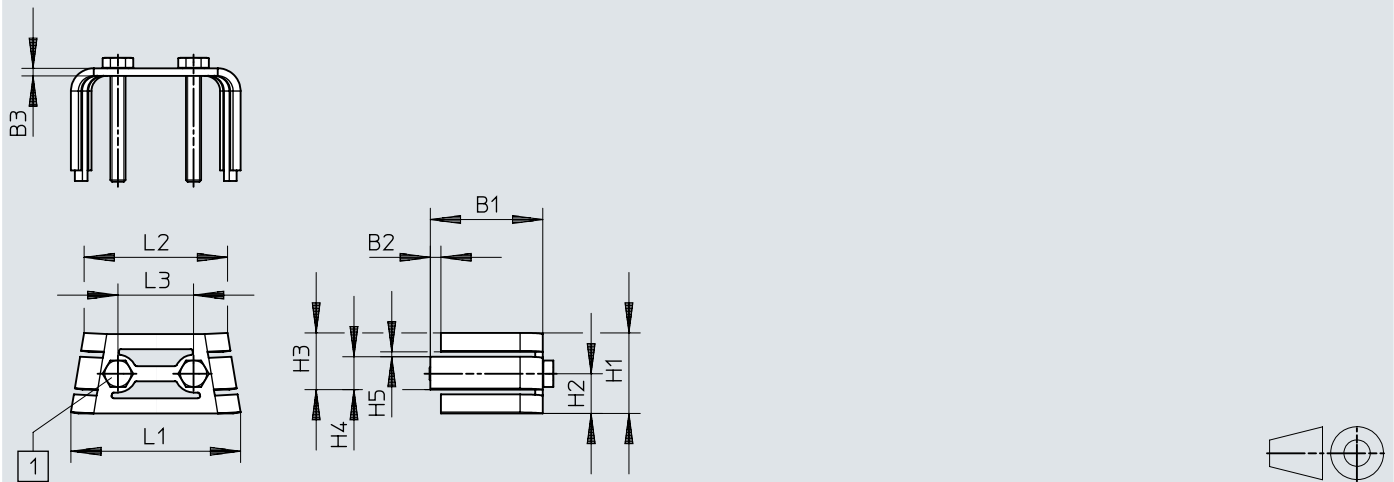

[1] DHAS-ME-H9-120: ISO 4017-M4x30-A2-70 screw

	B1	B2	B3	H1	H2	H3	H4	H5	L1	L2	L3
			±0,1					±0,1			±0,1
DHAS-ME-H9-120	29,8	2,8	2	21,3	10,5	15	8,7	1,3	44,9	38	20

Ordering data

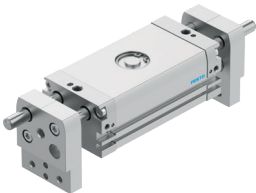
DHPL						
	Size	Total stroke	Mode of operation	Product weight	Part no.	Type
	10	20 mm	Double-acting	251 g	8112216	DHPL-10-20-P-A
		60 mm		377 g	8112215	DHPL-10-60-P-A
	16	30 mm		499 g	8112217	DHPL-16-30-P-A
		80 mm		802 g	8112218	DHPL-16-80-P-A
	20	40 mm		883 g	8112220	DHPL-20-40-P-A
		100 mm		1,407 g	8112219	DHPL-20-100-P-A
	25	50 mm		1,447 g	8112222	DHPL-25-50-P-A
		120 mm		2,297 g	8112221	DHPL-25-120-P-A
	32	70 mm		2,634 g	8112223	DHPL-32-70-P-A
		160 mm		4,154 g	8112224	DHPL-32-160-P-A
	40	100 mm		4,480 g	8112225	DHPL-40-100-P-A
		200 mm		6,480 g	8112226	DHPL-40-200-P-A

Peripherals

Peripherals overview

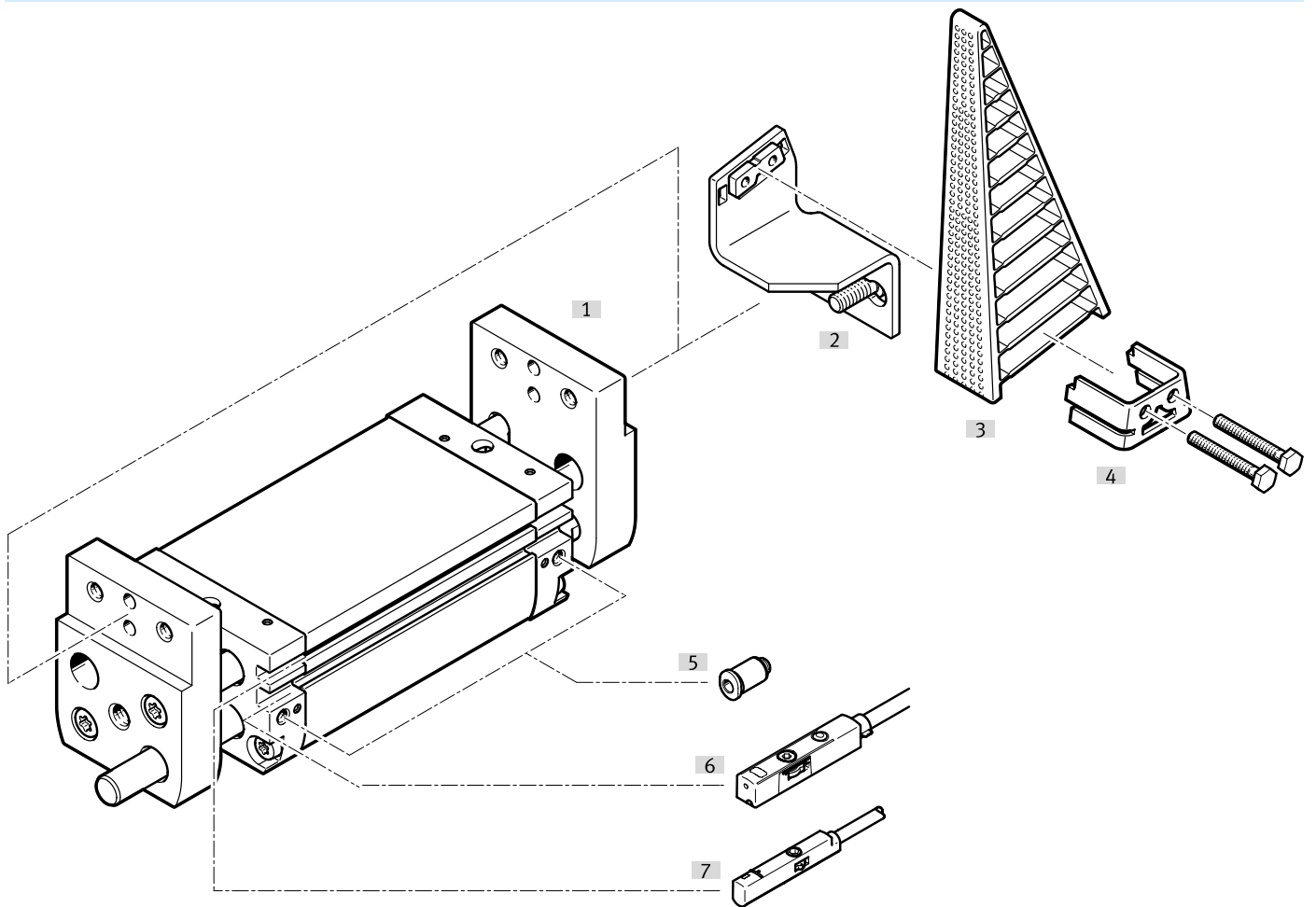

Accessories		→ Page/Internet
Type/order code	Description	
[1] Parallel gripper DHPL	Basic drive, double-acting	dhpl
[2] Mounting bracket HAMF-MA	- For mounting the adaptive gripper finger DHAS-GF on the gripper - Available for size 20, 25	27
[3] Adaptive gripper finger DHAS-GF	For flexible gripping	27
[4] Mounting kit DHAS-ME	For mounting the adaptive gripper finger DHAS-GF on the mounting bracket HAMF-MA	27
[5] Push-in fitting QS	For connecting tubing with standard O.D.	qs
[6] Proximity switch SMT-8/SDBT-MSB/SDBT-MSX	- For T-slot - For position sensing	27
[6] Position transmitter SDAS/SDAT	- For T-slot - For sensing the current position	28
[7] Proximity switches SMT-10/SDBC-MSB	- For round slot - For position sensing	28

Accessories

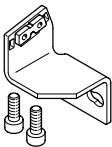
Mounting bracket HAMF-MA					
	Description	Material adapter bracket	Product weight	Part no.	Type
	For size 20	High-alloy stainless steel	82 g	8175305	HAMF-MA-B27-60-S1
			99 g	8175308	HAMF-MA-B27-80-S1
			129 g	8175314	HAMF-MA-B27-120-S1
	For size 25		96 g	8175315	HAMF-MA-B27-60-S2
			113 g	8175316	HAMF-MA-B27-80-S2
			142 g	8175317	HAMF-MA-B27-120-S2

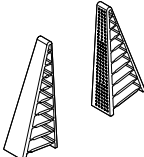
Adaptive gripper finger DHAS-GF					
	Description	Material clamp jaws	Product weight	Part no.	Type
	For HAMF-MA-B27-60-S1/S2	TPE-U(PU)	7 g	3998967	DHAS-GF-60-U-BU
	For HAMF-MA-B27-80-S1/S2		13 g	3998964	DHAS-GF-80-U-BU
	For HAMF-MA-B27-120-S1/S2		29 g	3998959	DHAS-GF-120-U-BU

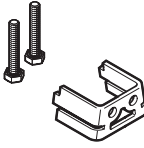
Mounting kit DHAS-ME					
	Description	Material adapter	Product weight	Part no.	Type
	For DHAS-GF-60-U-BU	High-alloy stainless steel	7 g	4464306	DHAS-ME-H9-60
	For DHAS-GF-80-U-BU		13 g	4463570	DHAS-ME-H9-80
	For DHAS-GF-120-U-BU		23 g	4461433	DHAS-ME-H9-120

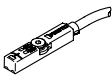
Proximity switch SMT-8M for T-slot, magneto-resistive						Further information → smt
	Type of mounting	Switching output	Electrical connection	Cable length	Part no.	Type
	Screw-clamped, Insertable in the slot from above	3-wire NPN N/O contact	Open end	2.5 m	★ 574338	SMT-8M-A-NS-24V-E-2,5-OE
			Plug M8, A-coded	0.3 m	★ 574339	SMT-8M-A-NS-24V-E-0,3-M8D
		3-wire PNP N/O contact	Open end	2.5 m	★ 574335	SMT-8M-A-PS-24V-E-2,5-OE
			Plug M8, A-coded	0.3 m	★ 574334	SMT-8M-A-PS-24V-E-0,3-M8D
		2-wire PNP N/O contact	Open end	5 m	★ 8165237	SMT-8M-A-ZS-24V-E-5,0-OE

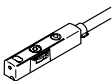
Proximity switch SDBT-MSX for T-slot, magnetic Hall						Further information → sdbt
	Switching output	Switching element function	Electrical connection	Cable length	Part no.	Type
	PNP/NPN, switchable	N/C or N/O contact, switchable	Open end	2.5 m	★ 8059121	SDBT-MSX-1L-PU-E-2.5-N-LE
				0.3 m	★ 8059124	SDBT-MSX-1L-NU-E-2.5-N-LE
			Plug M8, A-coded	0.3 m	★ 8059123	SDBT-MSX-1L-NU-E-0.3-N-M8
				0.3 m	★ 8059120	SDBT-MSX-1L-PU-E-0.3-N-M8

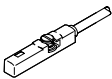
Proximity switch SDBT-MSB for T-slot, magneto-resistive						Further information → sdbt	
	Switching output	Switching element function	Electrical connection	Cable length	Part no.	Type	
	NPN	N/O contact	Open end	2 m	8150172	SDBT-MSB-1L-NU-K-2-LE	
			Plug M8, A-coded	0.3 m	8150175	SDBT-MSB-1L-NU-K-0.3-M8	
	PNP		Open end	2 m	8150171	SDBT-MSB-1L-PU-K-2-LE	
			Plug M8, A-coded	0.3 m	8150174	SDBT-MSB-1L-PU-K-0.3-M8	
	Non-contacting, 2-wire		N/O contact	Open end	2 m	8150173	SDBT-MSB-1L-ZU-K-2-LE
				Open end	2 m	8150173	SDBT-MSB-1L-ZU-K-2-LE

Accessories

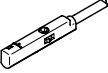
Proximity switch SMT-10M for round slot, magneto-resistive						Further information → smt
	Type of mounting	Switching output	Electrical connection	Cable length	Part no.	Type
	Screw-clamped, Insertable in the slot from above	3-wire NPN N/O contact	Open end	2.5 m	★ 551377	SMT-10M-NS-24V-E-2,5-L-OE
			Plug M8, A-coded	0.3 m	★ 551379	SMT-10M-NS-24V-E-0,3-L-M8D
		3-wire PNP N/O contact	Open end	2.5 m	★ 551373	SMT-10M-PS-24V-E-2,5-L-OE
			Plug M8, A-coded	0.3 m	★ 551375	SMT-10M-PS-24V-E-0,3-L-M8D
		2-wire PNP N/O contact	Open end	2.5 m	★ 551382	SMT-10M-ZS-24V-E-2,5-L-OE

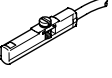
Proximity switch SDBC-MSB for round slot, magneto-resistive						Further information → sdbc
	Switching output	Switching element function	Electrical connection	Cable length	Part no.	Type
	NPN	N/O contact	Open end	2 m	8139724	SDBC-MSB-1L-NU-K-2-LE
			Plug M8, A-coded	0.3 m	8139727	SDBC-MSB-1L-NU-K-0.3-M8
	PNP		Open end	2 m	8139723	SDBC-MSB-1L-PU-K-2-LE
			Plug M8, A-coded	0.3 m	8139726	SDBC-MSB-1L-PU-K-0.3-M8
	Non-contacting, 2-wire		Open end	2 m	8139725	SDBC-MSB-1L-ZU-K-2-LE

Connecting cables NEBU, straight						
	Electrical connection 1, connector system	Electrical connection 2, connector system	Electrical connection 2, number of connections/cores	Cable length	Part no.	Type
	M8x1, A-coded, to EN 61076-2-104	Open end	3	2.5 m	541333	NEBU-M8G3-K-2.5-LE3
				5 m	541334	NEBU-M8G3-K-5-LE3

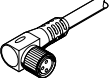
Connecting cables NEBU, angled						
	Electrical connection 1, connector system	Electrical connection 2, connector system	Electrical connection 2, number of connections/cores	Cable length	Part no.	Type
	M8x1, A-coded, to EN 61076-2-104	Open end	3	2.5 m	541338	NEBU-M8W3-K-2.5-LE3
				5 m	541341	NEBU-M8W3-K-5-LE3

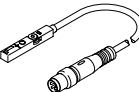
Position transmitter SDAS for T-slot, connector M8, A-coded						Further information → sdas
	Description	Sensing range	Electrical connection 1, number of connections/cores	Cable length	Part no.	Type
	Operating modes: two adjustable switching outputs; IO-Link®	52 mm	4	0.3 m	8063974	SDAS-MHS-M40-1L-PNLK-PN-E-0.3-M8

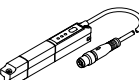
Position transmitter SDAT for T-slot, plug M8, A-coded						Further information → sdatt
	Sensing range	Analogue output	Electrical connection 1, number of connections/cores	Cable length	Part no.	Type
	0 ... 50.000 mm	4 - 20 mA	4	0.3 m	1531265	SDAT-MHS-M50-1L-SA-E-0.3-M8

Accessories

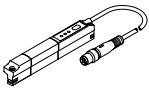
Position transmitter SDAT for T-slot, plug M8, A-coded						Further information → sdat
	Sensing range	Analogue output	Electrical connection 1, number of connections/ cores	Cable length	Part no.	Type
	0 ... 80.000 mm	4 - 20 mA	4	0.3 m	1531266	SDAT-MHS-M80-1L-SA-E-0.3-M8
	0 ... 100.000 mm				1531267	SDAT-MHS-M100-1L-SA-E-0.3-M8
	0 ... 125.000 mm				1531268	SDAT-MHS-M125-1L-SA-E-0.3-M8
	0 ... 160.000 mm				1531269	SDAT-MHS-M160-1L-SA-E-0.3-M8

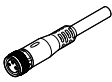
Connecting cables NEBU, straight						
	Electrical connection 1, connector system	Electrical connection 2, connector system	Electrical connection 2, number of connections/ cores	Cable length	Part no.	Type
	M8x1, A-coded, to EN 61076-2-104	Open end	4	2.5 m	541342	NEBU-M8G4-K-2.5-LE4
				5 m	541343	NEBU-M8G4-K-5-LE4

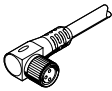
Connecting cables NEBU, angled						
	Electrical connection 1, connector system	Electrical connection 2, connector system	Electrical connection 2, number of connections/ cores	Cable length	Part no.	Type
	M8x1, A-coded, to EN 61076-2-104	Open end	4	2.5 m	541344	NEBU-M8W4-K-2.5-LE4
				5 m	541345	NEBU-M8W4-K-5-LE4