

Service unit combinations MSB-FRC, MS series

FESTO



Festo Core Range
Solves the majority of your automation tasks

With the Festo Core Range, we have selected the most important products and functions from our broad product catalogue, and added the quickest delivery.

Worldwide: Quickest delivery – wherever, whenever
Simply good: Expected high Festo quality
Fast: Easy and fast to select

The Core Range offers you the best value for your automation tasks.

Just look
for the
star!

Key features

Service unit components of the MS series

Solutions for every application

With its large product range, highly effective components and a wide choice of functions, the MS series from Festo offers a complete concept for compressed air preparation. It is suitable for simple standard applications as well as application-specific solutions with very high quality requirements. Available as individual components, pre-assembled combinations ex-stock,

application-specific combinations or complete turnkey solutions. The five sizes in the MS series achieve maximum flow rates with minimum space requirements.

Freely combinable function modules

Pressure regulators, on/off and soft-start valves with safety function, filters, pressure and flow sensors, dryers, sensors and lubricators can be assembled into a suitable solution for every task. With the modular structure the components can be combined as required. The simple connection system saves time because replacing individ-

ual modules does not require disassembling the entire combination. Many of the components are also UL and ATEX certified.

CAD models and configurator

Convenient tools for planning and selecting application-specific individual components and combinations. The product configurator lets you configure customised solutions quickly and transfer the order data without any hassle.

Engineering tools

Selection tool for choosing the right service unit combination without oversizing, and with the right air purity class:

→ www.festo.com/engineering/service-unit



Integrated sensors

Pressure and flow sensors



- Maximum machine availability thanks to controlled processes
- Reliable compressed air preparation and supply for the system
- Integrated or stand-alone
- Easy to connect with M8/M12 plug

Safety functions

Soft-start/quick exhaust valves
MS6-SV/MS9-SV



- Fast and reliable exhausting of systems up to Performance Level e, certified to EN ISO 13849-1
- Integrated soft-start function

Energy savings

Service unit combinations MSE6



- Fully automatic monitoring and regulation of compressed air supply
- Automatic shut-off of the compressed air in stand-by mode
- Detection and notification of leakages
- Condition monitoring of relevant process data

Intelligent mix of sizes



- Optimum flow rate with a size that is up to 18% smaller
- Excellent energy efficiency
- Cost-optimised combinations – save up to 30%!

Size differences

Size	MS2	MS4	MS6	MS9	MS12
Grid dimension [mm]	25	40	62	90	124
Connection sizes	M5, QS-6	G1/8, G1/4, G3/8	G1/4, G3/8, G1/2, G3/4	G1/2, G3/4, G1, G1 1/4, G1 1/2	G1, G1 1/4, G1 1/2, G2
Standard nominal flow rate $q_{nN}^{1)}$ [l/min]	350	1800	6500	20000	22000

1) Using pressure regulator MS-LR as an example

Key features

Note

Information

The next few pages provide a brief overview of the product range for the service unit components of the MS series.

You can find detailed information and all the technical data in the documentation for the relevant service unit component.

Accessories such as connecting plates or mounting brackets can be ordered either via the configurator or separately.

Design of a service unit

The order of the individual service unit components within a combination is relevant for safety and functionality. The service unit components cannot be combined in any order in the flow direction. They are subject to restrictions and rules.





The configurator for the service unit MSB is a reliable and convenient way of combining individual service unit components and it ensures compliance with the applicable rules. As a result, you get a fully assembled unit, including UL or ATEX certification, if necessary.

When combining a unit from individually configured and ordered service unit components, the points on the right must be adhered to under all circumstances.







- Regulators MS-LFR/LR/LRP are only permissible in the flow direction with the same or decreasing pressure regulation range
- Filters MS-LFR/LF/LFM/LFX are only permissible in the flow direction with an increasing grade of filtration
- Lubricators MS-LOE are not permitted in the flow direction upstream of a filter MS-LFR/LFM/LF/LFX, water separator MS-LWS or membrane air dryer MS-LDM1

- A micro filter MS-LFM must be installed in the flow direction upstream of an activated carbon filter MS-LFX or membrane air dryer MS-LDM1
- A flow sensor SFAM cannot be installed directly downstream of a regulator MS-LFR/LR; a branching module MS-FRM must be positioned between them
- A soft-start/quick exhaust valve MS-SV must be the last service unit component in the flow direction







Product range for service unit components of the MS series

Type	Description	Size	Pneumatic connection					
			Push-in connector	Female thread			Connecting plate with thread	
				M	G	NPT	G	NPT
Combinations								
Service unit combinations MSB-FRC								Datasheets → Internet: msb
	Combinations of filter regulator and lubricator	4	–	–	1/8, 1/4	–	–	–
		6	–	–	1/4, 3/8, 1/2	–	–	–
Service unit combinations MSB								
Service unit combinations MSB								Datasheets → Internet: msb
	Certain combinations predefined	4	–	–	1/4	–	–	–
		6	–	–	1/2	–	–	–
	Freely configurable combinations	4	–	–	1/8, 1/4	–	1/8, 1/4, 3/8	1/8, 1/4, 3/8
		6	–	–	1/4, 3/8, 1/2	–	1/4, 3/8, 1/2, 3/4	1/4, 3/8, 1/2, 3/4
		9	–	–	3/4, 1	3/4, 1	1/2, 3/4, 1, 1 1/4, 1 1/2	1/2, 3/4, 1, 1 1/4, 1 1/2
Service unit combinations MSE6								
Service unit combinations MSE6								Datasheets → Internet: mse6
	Combinations with fieldbus connection for measuring pressure, flow rate and consumption	6	–	–	–	–	1/2	–

Key features

Product range for service unit components of the MS series								
Type	Description	Size	Pneumatic connection					
			Push-in connector	Female thread			Connecting plate with thread	
				M	G	NPT	G	NPT
Individual devices								
Filter regulators MS-LFR Datasheets → Internet: ms2-lfr; ms4-lfr; ms6-lfr; ms9-lfr; ms12-lfr								
	Filter and pressure regulator in a single device, grade of filtration 5 or 40 µm	2	QS-6	M5	–	–	–	–
		4	–	–	1/8, 1/4	–	1/8, 1/4, 3/8	1/8, 1/4, 3/8
		6	–	–	1/4, 3/8, 1/2	–	1/4, 3/8, 1/2, 3/4	1/4, 3/8, 1/2, 3/4
		9	–	–	3/4, 1	3/4, 1	1/2, 3/4, 1, 1 1/4, 1 1/2	1/2, 3/4, 1, 1 1/4, 1 1/2
		12	–	–	–	–	1, 1 1/4, 1 1/2, 2	–
Filter regulators MS-LFR-B Datasheets → Internet: ms4-lfr-b; ms6-lfr-b								
	Filter and pressure regulator in a single device in polymer housing, grade of filtration 5 or 40 µm	4	–	–	1/4	–	–	–
		6	–	–	1/2	–	–	–
Filters MS-LF Datasheets → Internet: ms4-lf; ms6-lf; ms9-lf; ms12-lf								
	Grade of filtration 5 or 40 µm	4	–	–	1/8, 1/4	–	1/8, 1/4, 3/8	1/8, 1/4, 3/8
		6	–	–	1/4, 3/8, 1/2	–	1/4, 3/8, 1/2, 3/4	1/4, 3/8, 1/2, 3/4
		9	–	–	3/4, 1	3/4, 1	1/2, 3/4, 1, 1 1/4, 1 1/2	1/2, 3/4, 1, 1 1/4, 1 1/2
		12	–	–	–	–	1, 1 1/4, 1 1/2, 2	–
Fine and micro filters MS-LFM Datasheets → Internet: ms4-lfm; ms6-lfm; ms9-lfm; ms12-lfm								
	Grade of filtration 0.01 or 1 µm	4	–	–	1/8, 1/4	–	1/8, 1/4, 3/8	1/8, 1/4, 3/8
		6	–	–	1/4, 3/8, 1/2	–	1/4, 3/8, 1/2, 3/4	1/4, 3/8, 1/2, 3/4
		9	–	–	3/4, 1	3/4, 1	1/2, 3/4, 1, 1 1/4, 1 1/2	1/2, 3/4, 1, 1 1/4, 1 1/2
		12	–	–	–	–	1, 1 1/4, 1 1/2, 2	–
Activated carbon filters MS-LFX Datasheets → Internet: ms4-lfx; ms6-lfx; ms9-lfx; ms12-lfx								
	For removing liquid and gaseous oil particles	4	–	–	1/8, 1/4	–	1/8, 1/4, 3/8	1/8, 1/4, 3/8
		6	–	–	1/4, 3/8, 1/2	–	1/4, 3/8, 1/2, 3/4	1/4, 3/8, 1/2, 3/4
		9	–	–	3/4, 1	3/4, 1	1/2, 3/4, 1, 1 1/4, 1 1/2	1/2, 3/4, 1, 1 1/4, 1 1/2
		12	–	–	–	–	1, 1 1/4, 1 1/2, 2	–
Water separators MS-LWS Datasheets → Internet: ms6-lws; ms9-lws; ms12-lws								
	Remove condensate from compressed air, maintenance-free	6	–	–	1/4, 3/8, 1/2	–	1/4, 3/8, 1/2, 3/4	1/4, 3/8, 1/2, 3/4
		9	–	–	3/4, 1	3/4, 1	1/2, 3/4, 1, 1 1/4, 1 1/2	1/2, 3/4, 1, 1 1/4, 1 1/2
		12	–	–	–	–	1, 1 1/4, 1 1/2, 2	–





Key features

Product range for service unit components of the MS series								
Type	Description	Size	Pneumatic connection					
			Push-in connector	Female thread			Connecting plate with thread	
				M	G	NPT	G	NPT
Individual devices								
Pressure regulators MS-LR Datasheets → Internet: ms2-lr; ms4-lr; ms6-lr; ms9-lr; ms12-lr								
	For setting the required operating pressure, 4 pressure regulation ranges	2	QS-6	M5	–	–	–	–
		4	–	–	1/8, 1/4	–	1/8, 1/4, 3/8	1/8, 1/4, 3/8
		6	–	–	1/4, 3/8, 1/2	–	1/4, 3/8, 1/2, 3/4	1/4, 3/8, 1/2, 3/4
		9	–	–	3/4, 1	3/4, 1	1/2, 3/4, 1, 1 1/4, 1 1/2	1/2, 3/4, 1, 1 1/4, 1 1/2
		12	–	–	–	–	1, 1 1/4, 1 1/2, 2	–
Pressure regulators MS-LR-B Datasheets → Internet: ms4-lr-b; ms6-lr-b								
	For setting the required operating pressure, in a polymer housing	4	–	–	1/4	–	–	–
		6	–	–	1/2	–	–	–
Pressure regulators MS-LRP Datasheets → Internet: ms4-lrp; ms6-lrp								
	For configuring a regulator manifold with independent pressure regulation ranges. Pressure output is to the front or rear.	4	–	–	1/4	–	1/8, 1/4, 3/8	–
		6	–	–	1/2	–	1/4, 3/8, 1/2, 3/4	–
Precision pressure regulators MS-LRP Datasheets → Internet: ms6-lrp								
	For precise setting of the required operating pressure, 4 pressure regulation ranges, pressure hysteresis 0.02 bar	6	–	–	1/4, 3/8, 1/2	–	1/4, 3/8, 1/2, 3/4	1/4, 3/8, 1/2, 3/4
Precision pressure regulators MS-LRPB Datasheets → Internet: ms6-lrpb								
	For configuring a regulator manifold with independent pressure regulation ranges. Pressure output is to the front or rear.	6	–	–	1/2	–	1/4, 3/8, 1/2, 3/4	–
Lubricators MS-LOE Datasheets → Internet: ms4-loe; ms6-loe; ms9-loe; ms12-loe								
	Add a precisely adjustable amount of oil to the compressed air. The amount of oil mist is proportional to the compressed air flow rate.	4	–	–	1/8, 1/4	–	1/8, 1/4, 3/8	1/8, 1/4, 3/8
		6	–	–	1/4, 3/8, 1/2	–	1/4, 3/8, 1/2, 3/4	1/4, 3/8, 1/2, 3/4
		9	–	–	3/4, 1	3/4, 1	1/2, 3/4, 1, 1 1/4, 1 1/2	1/2, 3/4, 1, 1 1/4, 1 1/2
		12	–	–	–	–	1, 1 1/4, 1 1/2, 2	–

Key features

Product range for service unit components of the MS series								
Type	Description	Size	Pneumatic connection			Connecting plate with thread		
			Push-in connector	Female thread		G		NPT
			M	G	NPT	G	NPT	
Individual devices								
On/off valves MS-EM						Datasheets → Internet: ms4-em; ms6-em; ms9-em; ms12-em		
	Manually actuated on/off valve for pressurising and exhausting pneumatic systems.	4	–	–	1/8, 1/4	–	1/8, 1/4, 3/8	1/8, 1/4, 3/8
		6	–	–	1/4, 3/8, 1/2	–	1/4, 3/8, 1/2, 3/4	1/4, 3/8, 1/2, 3/4
		9	–	–	3/4, 1	3/4, 1	1/2, 3/4, 1, 1 1/4, 1 1/2	1/2, 3/4, 1, 1 1/4, 1 1/2
		12	–	–	–	–	1, 1 1/4, 1 1/2, 2	–
On/off valves MS-EE								
On/off valves MS-EE						Datasheets → Internet: ms4-ee; ms6-ee; ms9-ee; ms12-ee		
	Electrically actuated on/off valve for pressurising and exhausting pneumatic systems.	4	–	–	1/8, 1/4	–	1/8, 1/4, 3/8	1/8, 1/4, 3/8
		6	–	–	1/4, 3/8, 1/2	–	1/4, 3/8, 1/2, 3/4	1/4, 3/8, 1/2, 3/4
		9	–	–	3/4, 1	3/4, 1	1/2, 3/4, 1, 1 1/4, 1 1/2	1/2, 3/4, 1, 1 1/4, 1 1/2
		12	–	–	–	–	1, 1 1/4, 1 1/2, 2	–
On/off valves MS-EE-B								
On/off valves MS-EE-B						Datasheets → Internet: ms4-ee-b; ms6-ee-b		
	Electrically actuated on/off valve in polymer housing for pressurising and exhausting pneumatic systems.	4	–	–	1/4	–	–	–
		6	–	–	1/2	–	–	–
Soft-start valves MS-DL								
Soft-start valves MS-DL						Datasheets → Internet: ms4-dl; ms6-dl; ms12-dl		
	Pneumatically actuated soft-start valve for slow pressurisation and exhaust of pneumatic installations.	4	–	–	1/8, 1/4	–	1/8, 1/4, 3/8	1/8, 1/4, 3/8
		6	–	–	1/4, 3/8, 1/2	–	1/4, 3/8, 1/2, 3/4	1/4, 3/8, 1/2, 3/4
		12	–	–	–	–	1, 1 1/4, 1 1/2, 2	–
Soft-start valves MS-DE								
Soft-start valves MS-DE						Datasheets → Internet: ms4-de; ms6-de; ms12-de		
	Electrically actuated soft-start valve for slowly pressurising and exhausting pneumatic systems.	4	–	–	1/8, 1/4	–	1/8, 1/4, 3/8	1/8, 1/4, 3/8
		6	–	–	1/4, 3/8, 1/2	–	1/4, 3/8, 1/2, 3/4	1/4, 3/8, 1/2, 3/4
		12	–	–	–	–	1, 1 1/4, 1 1/2, 2	–
On/off valves MS-EDE-B								
On/off valves MS-EDE-B						Datasheets → Internet: ms4-edeb; ms6-edeb		
	Electrically actuated soft-start valve in polymer housing for slowly pressurising and exhausting pneumatic systems.	4	–	–	1/4	–	–	–
		6	–	–	1/2	–	–	–
Soft-start/quick exhaust valves MS-SV								
Soft-start/quick exhaust valves MS-SV						Datasheets → Internet: ms6-sv; ms9-sv		
	For gradually increasing pressurisation and quick, safe pressure reduction in pneumatic piping systems. Up to category 1, PL c.	6	–	–	1/2	–	1/4, 3/8, 1/2, 3/4	1/4, 3/8, 1/2, 3/4
		9	–	–	3/4, 1	3/4, 1	1/2, 3/4, 1, 1 1/4, 1 1/2	1/2, 3/4, 1, 1 1/4, 1 1/2
	Up to category 3, PL d. Up to category 4, PL e in the case of optional extension.	6	–	–	1/2	–	1/4, 3/8, 1/2, 3/4	1/4, 3/8, 1/2, 3/4
	Up to category 4, PL e.	6	–	–	1/2	–	1/4, 3/8, 1/2, 3/4	–

Key features

Product range for service unit components of the MS series								
Type	Description	Size	Pneumatic connection				Connecting plate with thread	
			Push-in connector	Female thread			G	NPT
				M	G	NPT		
Individual devices								
Membrane air dryers MS-LDM1							Datasheets → Internet: ms4-ldm; ms6-ldm	
	Wear-free membrane dryer with internal air consumption	4	–	–	1/8, 1/4	–	1/8, 1/4, 3/8	1/8, 1/4, 3/8
		6	–	–	1/4, 3/8, 1/2	–	1/4, 3/8, 1/2, 3/4	1/4, 3/8, 1/2, 3/4
Branching modules MS-FRM								
Compressed air distributors with 4 connections							Datasheets → Internet: ms4-frm; ms6-frm; ms9-frm; ms12-frm	
		4	–	–	1/8, 1/4	–	1/8, 1/4, 3/8	–
		6	–	–	1/4, 3/8, 1/2	–	1/4, 3/8, 1/2, 3/4	–
		9	–	–	3/4, 1	3/4, 1	1/2, 3/4, 1, 1 1/4, 1 1/2	1/2, 3/4, 1, 1 1/4, 1 1/2
		12	–	–	–	–	1, 1 1/4, 1 1/2, 2	–
Distributor blocks MS-FRM-FRZ								
Compressed air distributors with 4 connections and half the grid width							Datasheets → Internet: ms4-frm-frz; ms6-frm-frz	
		4	–	–	–	–	–	–
		6	–	–	–	–	–	–
Flow sensors SFAM								
For absolute flow rate information and cumulative air consumption measurement							Datasheets → Internet: sfam	
		6	–	–	–	–	1/2	1/2
		9	–	–	–	–	1, 1 1/2	1, 1 1/2

Peripherals overview

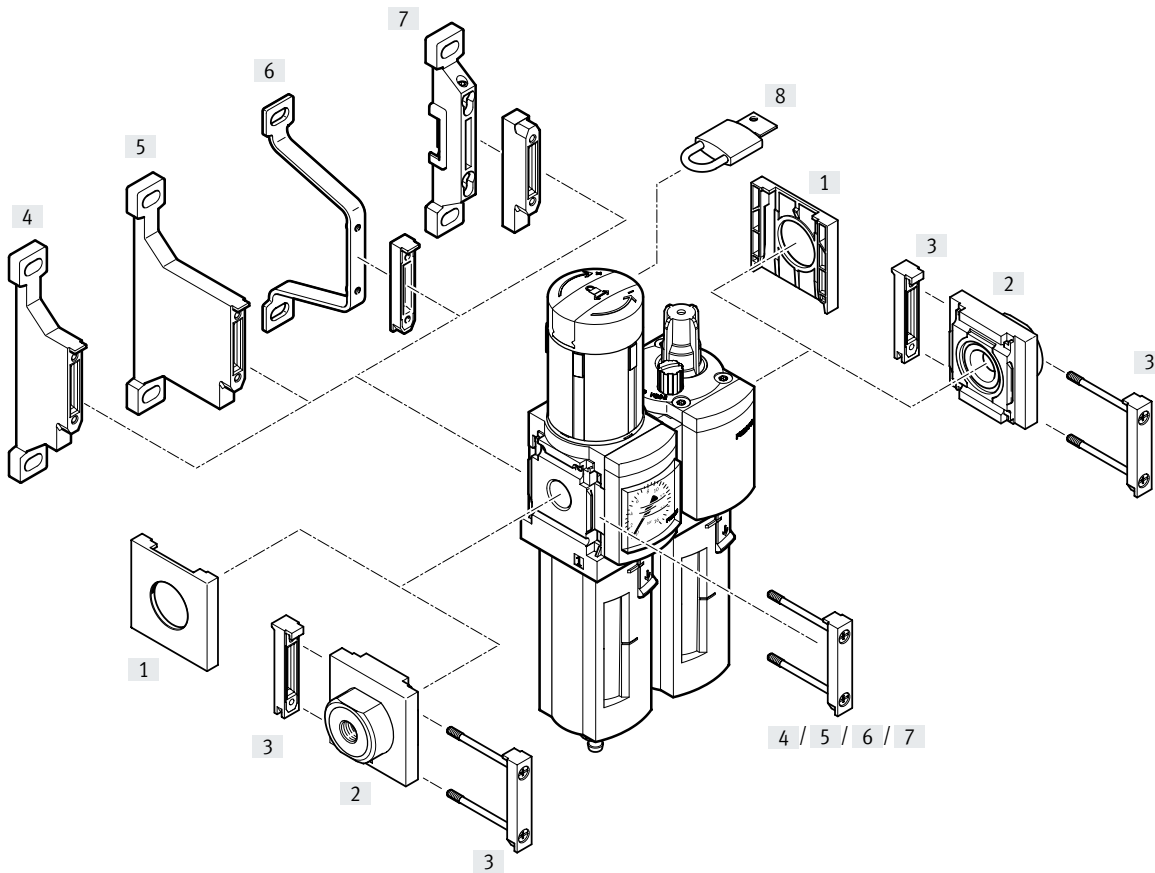

Mounting attachments and accessories		→ Page/Internet
[1]	Cover cap MS4/6-END	ms4-end, ms6-end
[2]	Connecting plate SET MS4/6-AG...	ms4-ag, ms6-ag
[3]	Module connector MS4/6-MV	ms4-mv, ms6-mv
[4]	Mounting bracket MS4/6-WP	ms4-wp, ms6-wp
[5]	Mounting bracket MS4/6-WPB	ms4-wp, ms6-wp
[6]	Mounting bracket MS4/6-WPE	ms4-wp, ms6-wp
[7]	Mounting bracket MS4/6-WPM	ms4-wp, ms6-wp
[8]	Padlock LRVS-D	17

Type codes

001	Series	
MSB	Service unit component MS series	
002	Size	
4	Grid dimension 40 mm	
003	Pneumatic connection	
1/8	Female thread G1/8	
1/4	Female thread G1/4	
004	Function	
FRC		

005	Service unit component equipment	
J1	Filter regulator, 0.5 ... 12 bar, 40 µm, plastic bowl with plastic bowl guard, manual condensate drain, lockable rotary knob	
J2	Filter regulator, 0.5 ... 12 bar, 40 µm, plastic bowl with plastic bowl guard, fully automatic condensate drain, lockable rotary knob	
J3	Filter regulator, 0.5 ... 12 bar, 5 µm, plastic bowl with plastic bowl guard, manual condensate drain, lockable rotary knob	
J5	Filter regulator, 0.3 ... 7 bar, 40 µm, plastic bowl with plastic bowl guard, manual condensate drain, lockable rotary knob	
J120	Filter regulator, lockable, 0.3 ... 7 bar, 40 µm, plastic bowl with plastic bowl guard, manual condensate drain, MPa, lockable rotary knob	
M1	Lubricator, plastic bowl with plastic bowl guard	
006	Flow direction	
	Flow direction from left to right	
Z	Flow direction from right to left	

Type codes

001	Series	
MSB	Service unit component MS series	
002	Size	
6	Grid dimension 62 mm	
003	Pneumatic connection	
1/4	Female thread G1/4	
3/8	Female thread G3/8	
1/2	Female thread G1/2	
004	Function	
FRC		

005	Service unit component equipment	
J1	Filter regulator, 0.5 ... 12 bar, 40 µm, plastic bowl with plastic bowl guard, manual condensate drain, lockable rotary knob	
J2	Filter regulator, 0.5 ... 12 bar, 40 µm, plastic bowl with plastic bowl guard, fully automatic condensate drain, lockable rotary knob	
J3	Filter regulator, 0.5 ... 12 bar, 5 µm, plastic bowl with plastic bowl guard, manual condensate drain, lockable rotary knob	
J5	Filter regulator, 0.3 ... 7 bar, 40 µm, plastic bowl with plastic bowl guard, manual condensate drain, lockable rotary knob	
J9	Filter regulator, 0.5 ... 12 bar, 5 µm, metal bowl guard with manual condensate drain, lockable rotary knob	
J10	Filter regulator, 0.5 ... 12 bar, 5 µm, metal bowl with fully automatic condensate drain, lockable rotary knob	
J11	Filter regulator, 0.5 ... 12 bar, 40 µm, metal bowl guard with manual condensate drain, lockable rotary knob	
J12	Filter regulator, 0.5 ... 12 bar, 40 µm, metal bowl guard with fully automatic condensate drain, lockable rotary knob	
J120	Filter regulator, lockable, 0.3 ... 7 bar, 40 µm, plastic bowl with plastic bowl guard, manual condensate drain, MPa, lockable rotary knob	
M1	Lubricator, plastic bowl with plastic bowl guard	
M2	Lubricator, metal bowl	
006	Flow direction	
	Flow direction from left to right	
Z	Flow direction from right to left	



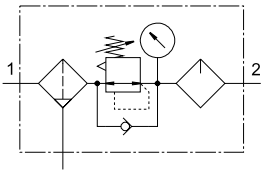

Datasheet

With manual rotary
condensate drain

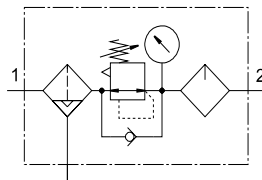

Fully automatic



-  Flow rate
850 ... 4800 l/min
-  Temperature range
-10 ... +60°C
-  Operating pressure
1.5 ... 20 bar
-  www.festo.com



- Filter, regulator and lubricator functions in a single unit
- High flow rate and highly efficient in removing contaminants
- Good regulation characteristics with minimal pressure hysteresis
- Set values are secured by locking the rotary knob
- Lockable rotary knob
- Two pressure regulation ranges: 0.3... 7 bar and 0.5 ... 12 bar
- Available with manual or integrated, fully automatic condensate drain
- Choice of filter inserts 5 µm or 40 µm
- New filter cartridges
→ page 17
Festo special oil → page 17

General technical data		
Size	MSB4	MSB6
Pneumatic connection 1, 2	G1/8	-
	G1/4	G1/4
	-	G3/8
	-	G1/2
Design	Filter regulator with pressure gauge	
	Proportional standard mist lubricator	
Regulator function	Output pressure constant, with primary pressure compensation, with return flow, with secondary exhausting	
Type of mounting	With accessories	
Mounting position	Vertical ±5°	
Grade of filtration [µm]	5	
	40	
Air purity class at the output	Compressed air to ISO 8573-1:2010 [6:4:-] (grade of filtration 5 µm)	
	Compressed air to ISO 8573-1:2010 [7:4:-] (grade of filtration 40 µm)	
Bowl guard	Plastic bowl guard	Plastic bowl guard
	-	Integrated as metal bowl
Condensate drain	Manual	
	Fully automatic	
Actuator lock	Rotary knob with detent, can be locked using accessories	
Pressure regulation range [bar]	0.3 ... 7	
	0.5 ... 12	
Display pressure	With pressure gauge	

† Note: This product conforms to ISO 1179-1 and ISO 228-1.

Datasheet

Standard nominal flow rate $q_{nN}^{1)}$ [l/min]					
Size	MSB4			MSB6	
Pneumatic connection	G1/8	G1/4	G1/4	G3/8	G1/2
Pressure regulation range 0.3 ... 7 bar					
Grade of filtration	40 μ m	–	1400	–	4800
Pressure regulation range 0.5 ... 12 bar					
Grade of filtration	5 μ m	–	850	–	3600
	40 μ m	850	900	1900	3500

1) Measured at $p_1 = 10$ bar and $p_2 = 6$ bar, $\Delta p = 1$ bar.

† 125 l/min must be available for the fully automatic condensate drain to close correctly.

Operating and environmental conditions					
Condensate drain	Manual			Fully automatic	
Size	MSB4		MSB6		MSB6
Operating pressure [bar]	1.5 ... 14		1.5 ... 20		2 ... 12
Operating medium	Compressed air to ISO 8573-1:2010 [–:4:–]			Compressed air to ISO 8573-1:2010 [7:4:–]	
	Inert gases				
Note on the operating/pilot medium	Lubricated operation possible (in which case lubricated operation will always be required)				
Ambient temperature [°C]	–10 ... +60				
Temperature of medium [°C]	–10 ... +60				
Storage temperature [°C]	–10 ... +60				
Corrosion resistance class CRC ¹⁾	2				
Food-safe ²⁾	See supplementary material information				

1) Additional information: www.festo.com/x/topic/kbk

2) Additional information: www.festo.com/catalogue/ms → Support/Downloads.

Weight [g]				
Size	MSB4		MSB6	
With plastic bowl guard	500		1495	
With metal bowl	–		1713	

Materials

Sectional view

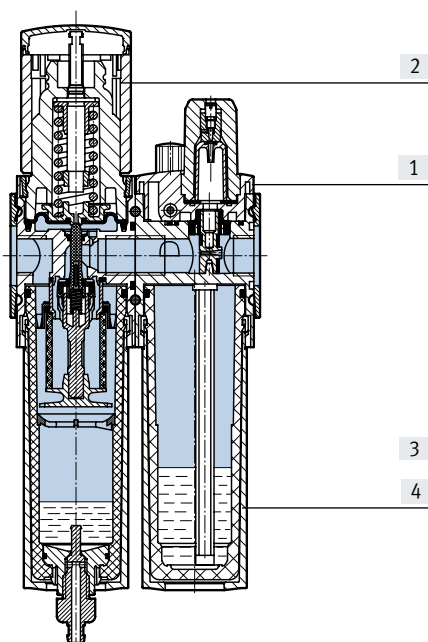

Service unit		
[1]	Housing	Die-cast aluminium
[2]	Rotary knob	PA/POM
[3]	Plastic bowl guard	PC
[4]	Metal bowl	Wrought aluminium alloy
–	Seals	NBR
PWIS conformity		VDMA24364-B1/B2-L

Datasheet

Standard flow rate q_n as a function of output pressure p_2

Pressure regulation range 0.3 ... 7 bar Grade of filtration 5 μm
MSB4-1/8

Grade of filtration 40 μm

Input pressure $p_1 = 10$ bar

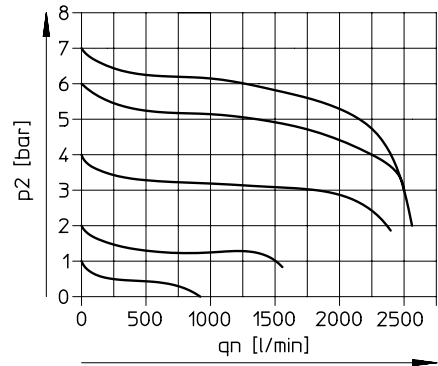

Pressure regulation range 0.5 ... 12 bar Grade of filtration 5 μm
MSB4-1/8

Grade of filtration 40 μm

Input pressure $p_1 = 10$ bar

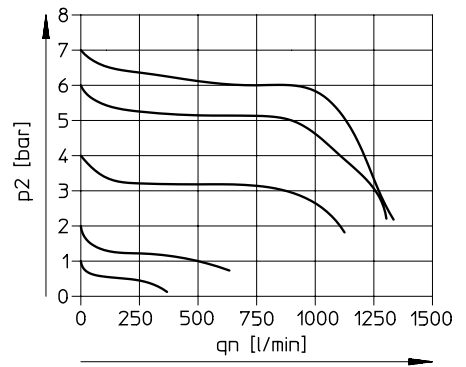

MSB4-1/4

Input pressure $p_1 = 10$ bar

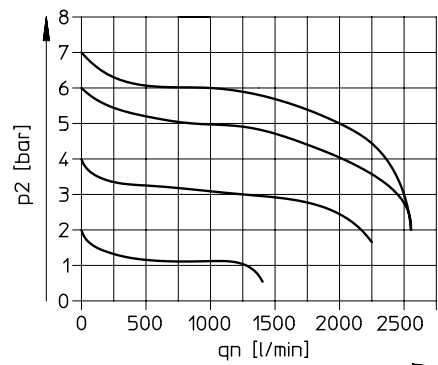
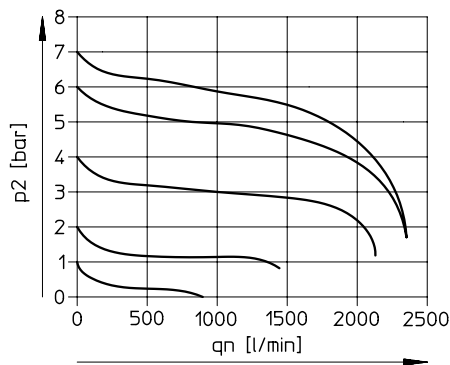

Datasheet

Standard flow rate q_n as a function of output pressure p_2

Pressure regulation range 0.3 ... 7 bar Grade of filtration 5 μm
MSB6-1/2

Grade of filtration 40 μm

Input pressure $p_1 = 10$ bar

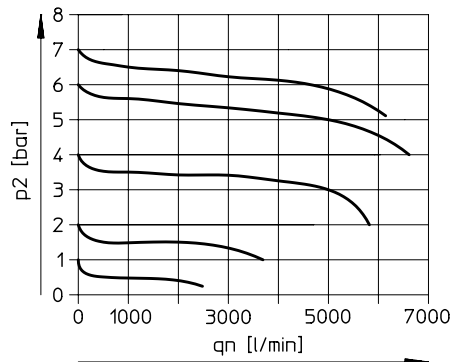

Pressure regulation range 0.5 ... 12 bar Grade of filtration 5 μm
MSB6-1/4

Grade of filtration 40 μm

Input pressure $p_1 = 10$ bar

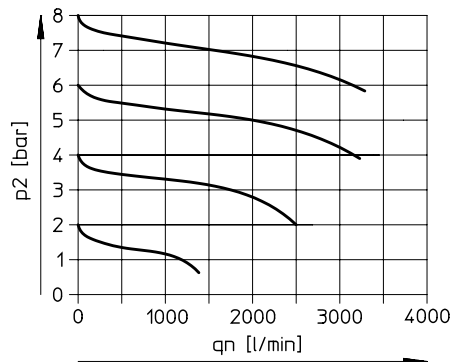

MSB6-3/8

Input pressure $p_1 = 10$ bar

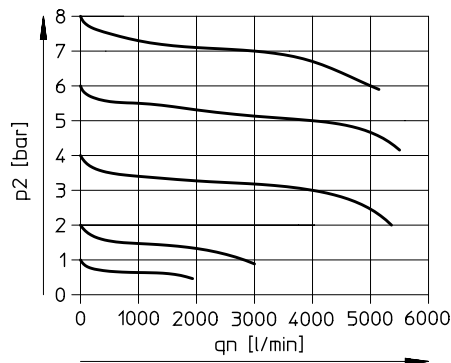

MSB6-1/2

Input pressure $p_1 = 10$ bar

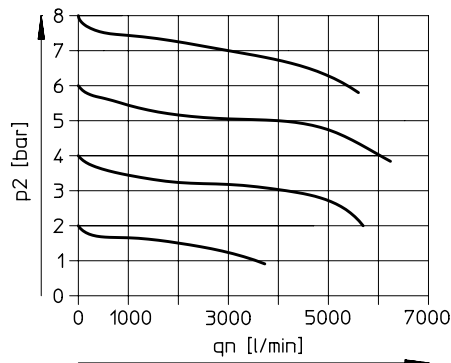
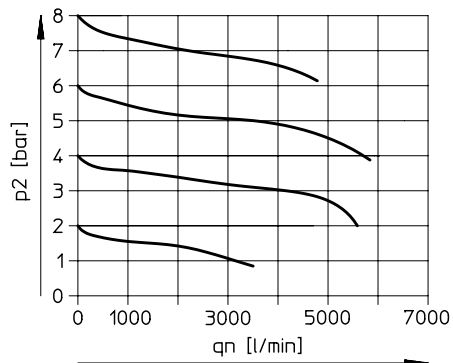

Datasheet

Dimensions

Download CAD data → www.festo.com

With pressure gauge, display unit [bar]

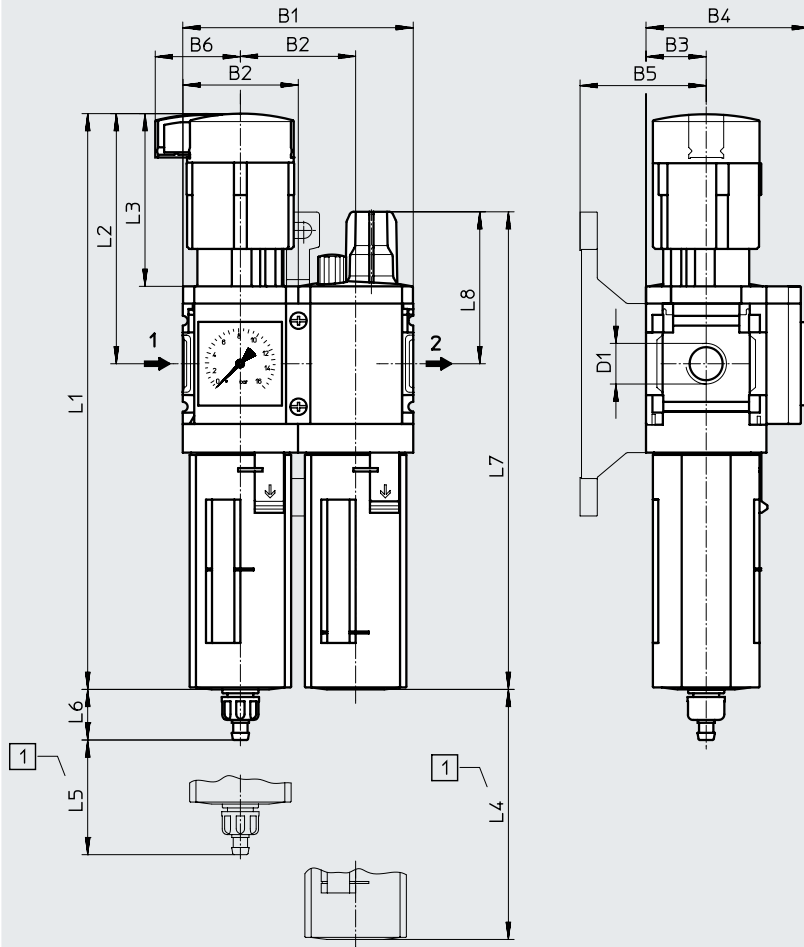

[1] Installation dimension

→ Flow direction

Type	B1	B2	B3	B4	B5	B6	D1	L1	L2	L3	L4	L5	L6		L7	L8
													Manual	Fully automatic		
MSB4-1/8	80.4	40.2	21	57	44	29.7	G1/8	201	87	60	80	25	17.7	20.4	167	53
MSB4-1/4							G1/4									
MSB6-1/4	124	62	31	77	54	38.8	G1/4	284.8	134.5	95.5	130	68	15.8	18.5	215.3	65.6
MSB6-3/8							G3/8									
MSB6-1/2							G1/2									

† Note: This product conforms to ISO 1179-1 and ISO 228-1.

Datasheet

★ Core Range

Ordering data					
Size	Connection	Condensate drain	Grade of filtration [µm]	Part no.	Type
Pressure regulation range 0.5 ... 12 bar, plastic bowl guard, pressure gauge with outer scale in bar and inner scale in psi					
Flow direction from left to right					
MSB4	G1/4	Manual	40	★ 531117	MSB4-1/4-FRC5:J1M1
MSB6	G1/2	Manual	40	★ 530244	MSB6-1/2-FRC5:J1M1
Flow direction from right to left					
MSB4	G1/4	Manual	40	531118	MSB4-1/4-FRC5:J1M1-Z
MSB6	G1/2	Manual	40	530245	MSB6-1/2-FRC5:J1M1-Z
Ordering data					
Size	Connection	Condensate drain	Grade of filtration [µm]	Part no.	Type
Pressure regulation range 0.3 ... 7 bar, plastic bowl guard, pressure gauge with outer scale in MPa					
MSB4	G1/4	Manual	40	8042669	MSB4-1/4-FRC13:J120M1
MSB6	G1/2	Manual	40	8042673	MSB6-1/2-FRC13:J120M1
Pressure regulation range 0.3 ... 7 bar, plastic bowl guard, pressure gauge with outer scale in bar and inner scale in psi					
MSB4	G1/4	Manual	40	531109	MSB4-1/4-FRC1:J5M1
MSB6	G1/2	Manual	40	530230	MSB6-1/2-FRC1:J5M1
Pressure regulation range 0.5 ... 12 bar, plastic bowl guard, pressure gauge with outer scale in bar and inner scale in psi					
MSB4	G1/8	Manual	40	531133	MSB4-1/8-FRC5:J1M1
	G1/4		5	531121	MSB4-1/4-FRC7:J3M1
	G1/4	Fully automatic	40	531119	MSB4-1/4-FRC6:J2M1
MSB6	G1/4	Manual	40	530268	MSB6-1/4-FRC5:J1M1
	G3/8		40	530292	MSB6-3/8-FRC5:J1M1
	G1/2		5	530248	MSB6-1/2-FRC7:J3M1
	G1/2	Fully automatic	40	530246	MSB6-1/2-FRC6:J2M1
Pressure regulation range 0.5 ... 12 bar, metal bowl, pressure gauge with outer scale in bar and inner scale in psi					
MSB6	G1/2	Manual	40	530252	MSB6-1/2-FRC9:J11M2
			5	530234	MSB6-1/2-FRC11:J9M2
		Fully automatic	40	530232	MSB6-1/2-FRC10:J12M2
			5	530236	MSB6-1/2-FRC12:J10M2

Accessories

Filter cartridges



Ordering data

Size	Grade of filtration [µm]	Part no.	Type
MS4	5 (colour: blue)	534501	MS4-LFP-C
	40 (colour: white)	534502	MS4-LFP-E
MS6	5 (colour: blue)	534499	MS6-LFP-C
	40 (colour: white)	534500	MS6-LFP-E

Special oil



Ordering data

Scope of delivery	Part no.	Type
1 litre	152811	OFSW-32

Ordering data – Padlock LRVS-D

	Weight [g]	Part no.	Type
	120	193786	LRVS-D