

Stepper motors EMMS-ST

FESTO

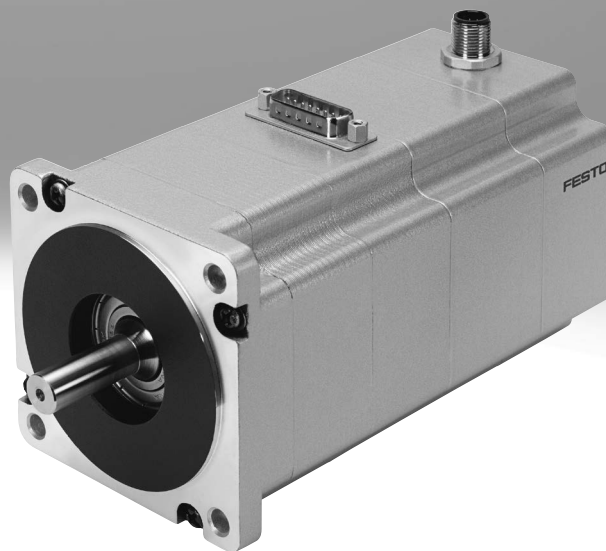

Festo core product range
Covers 80% of your automation tasks

Worldwide:

Always in stock

Superb:

Festo quality at an attractive price

Easy:

Simplified procurement and warehousing

★ Generally ready for dispatch from the factory within 24 hours

In stock at 13 Service Centres worldwide

More than 2200 products

★ Generally ready for dispatch from the factory within 5 days

Assembled for you at 4 Service Centres worldwide

Up to 6×10^{12} variants per product family

Just look
for the
star!

Key features

Everything from a single source

Motors

→ Page 4



- Conforms to standard IEC 60034
- 2-phase hybrid technology
- Optionally integrated encoder (closed loop)
- Sinusoidal current injection
- Optionally with holding brake
- Degree of protection: IP54



Gear unit EMGA-SST

→ Page 13



- Planetary gear unit
- Gear ratio $i = 3, 5, 8, 12$
- Life-time lubrication
- Degree of protection: IP54

Servo drive CMMT-ST

→ Internet: cmmt-st



- Servo drive for operating stepper motors and brushless direct current motors
- Options for point-to-point and interpolating motion and for precise positioning
- Primary voltage from 24 ... 48 V DC
- Position controller
- Speed controller
- Force controller
- Range of control functions
- Interfaces:
 - EtherCAT
 - PROFINET RT/IRT
 - EtherNet/IP

Power supply units CACN

→ Internet: cacn



- Sturdy mechanical system
- Input voltage range 100 ... 240 V AC
- Output voltage 24, 48 V DC
- Output current 5, 10, 20 A

Motor and encoder cables

NEBM → Page 13

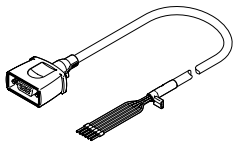

- Can be used in a wide temperature range
- Screened cables
- Suitable for energy chains
- Degree of protection IP65

Axial kits EAMM

→ Internet: eamm



- Specific kits for all electromechanical axes from Festo

Type codes

001	Series	
EMMS	Motor	

002	Motor type	
ST	Stepper motor ST	

003	Flange size, motors	
28	28	
42	42	
57	57	
87	87	

004	Length	
S	Short	
M	Centre	
L	Long	

005	Electrical connection	
S	Straight plug	

006	Measuring unit	
	None	
E	Encoder	

007	Brake	
	None	
B	With brake	

008	Generation	
	1st generation	
G2	2nd generation	

Data sheet

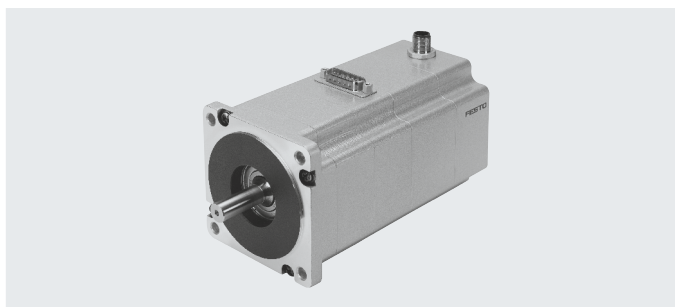

General technical data			
Size		28	42
Motor			
Nominal voltage	[V DC]	48	48
Nominal current	[A]	1.4	1.8
Max. rotational speed ¹⁾	[rpm]	6000	1740
Holding torque	[Nm]	0.09	0.5
Voltage constant, phase	[mVmin]	6	23
Step angle	[°]	1.8 ±5%	1.8 ±5%
Winding resistance	[Ω]	2.3 ±15%	1.75 ±15%
Winding inductance	[mH]	1.4	3.3
Output moment of inertia	[kg cm ²]	0.01 8/0.025 ²⁾	0.08 2/0.095 ²⁾
Radial load on shaft	[N]	20	20
Axial load on shaft	[N]	7	7
Mass moment of inertia of rotor	[kgcm ²]	0.018	0.082
Brake			
Operating voltage	[V DC]	24 ±10%	24 ±10%
Power	[W]	8	8
Holding torque	[Nm]	0.2	0.4
Mass moment of inertia	[kgcm ²]	0.007	0.013
Response delay	[ms]	2/6	2/6
Separation time	[ms]	10	10

1) Theoretical max. rotational speed while idling at nominal voltage

2) With brake

Size		57-S	57-M
Motor			
Nominal voltage	[V DC]	48	
Nominal current	[A]	5	
Max. rotational speed ¹⁾	[rpm]	2720	1940
Holding torque	[Nm]	0.8	1.4
Voltage constant, phase	[mVmin]	12	25.5
Step angle	[°]	1.8 ±5%	
Winding resistance	[Ω]	0.15 ±10%	0.25 ±10%
Winding inductance	[mH]	0.5	0.95
Output moment of inertia	[kg cm ²]	0.2 9/0.30 ²⁾	0.4 8/0.5 ²⁾
Radial load on shaft	[N]	52	
Axial load on shaft	[N]	10	
Mass moment of inertia of rotor	[kgcm ²]	0.29	0.48
Brake			
Operating voltage	[V DC]	24 ±10%	
Power	[W]	8	10
Holding torque	[Nm]	0.4	1
Mass moment of inertia	[kgcm ²]	0.01	0.02
Response delay	[ms]	2/6	2/6
Separation time	[ms]	10	12

1) Theoretical max. rotational speed while idling at nominal voltage

2) With brake

Data sheet

General technical data		87-S	87-M	87-L
Size				
Motor				
Nominal voltage	[V DC]	48		
Nominal current	[A]	9.5		
Max. rotational speed ¹⁾	[rpm]	2130	550	430
Holding torque	[Nm]	2.5	5.9	9.3
Voltage constant, phase	[mVmin]	19	68.6	77.2
Step angle	[°]	1.8 ±5%		
Winding resistance	[Ω]	0.1 ±10%	0.23 ±10%	0.23 ±10%
Winding inductance	[mH]	0.45	2.6	2.7
Output moment of inertia	[kg cm ²]	1/1.07 ²⁾	1.9/1.97 ²⁾	3/3.07 ²⁾
Radial load on shaft	[N]	200		
Axial load on shaft	[N]	65		
Mass moment of inertia of rotor	[kgcm ²]	1	1.9	3
Brake				
Operating voltage	[V DC]	24 ±10%		
Power	[W]	11		
Holding torque	[Nm]	2		
Mass moment of inertia	[kgcm ²]	0.07		
Response/Release delay	[ms]	2/6	2/6	2/6
Separation time	[ms]	25		

1) Theoretical max. rotational speed while idling at nominal voltage

2) With brake

Technical data – Encoder

Rotor position encoder	Incremental
Rotor position encoder measuring principle	Optical
Pulses/revolution	[1/rev] 500
Interface	RS422, TTL, AB channel, zero index
Operating voltage	[V DC] 5

Weights [g]

Size	28	42	57-S	57-M	87-S	87-M	87-L
Product weight	268	360	870	1100	1950	3050	4200
With encoder	295	450	970	1200	2100	3200	4350
With brake	356	540	1090	1320	2350	3450	4600
With encoder and brake	383	600	1150	1380	2500	3600	5000

Operating and environmental conditions

Size	28	42	57-S	57-M	87-S	87-M	87-L
Insulation class	B						
Thermal class to EN 60034-1	B						
Rating class to EN 60034-1	S1						
Degree of protection: motor shaft	IP40						
Degree of protection: motor housing	IP65		IP54				
Ambient temperature	[°C]	-10 ... +50					
Storage temperature	[°C]	-20 ... +70					
Relative humidity (non-condensing)	[%]	0 ... 85					
CE marking (see declaration of conformity)	To EU EMC Directive ¹⁾						
UKCA marking (see declaration of conformity)	UK instructions for EMC UK RoHS instructions						
Certification	c UL us - Recognized (OL) RCM compliance mark						
PWIS conformity	VDMA24364-B2-L						
Note on materials	RoHS-compliant						

1) For information about the area of use, see the EC declaration of conformity: www.festo.com/sp → Certificates.

If the devices are subject to usage restrictions in residential, commercial or light-industrial environments, further measures for the reduction of the emitted interference may be necessary.

Data sheet

Pin allocation

Motor connection

Size 28

Size 42, 57

Size 87

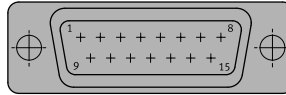
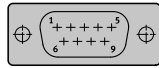
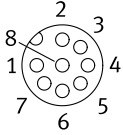

PIN	Function
1	String A
2	String A/
3	String B
4	String B/
5	n. c.
6	n. c.
7	Brake (24 V)
8	Brake (0 V)
9	-

PIN	Function
1	String A
2	String A
3	String A/
4	String A/
5	String B
6	String B
7	String B/
8	String B/
9	n. c.
10	n. c.
11	Brake (24 V)
12	Brake (0 V)
13	n. c.
14	n. c.
15	n. c.

Encoder connection

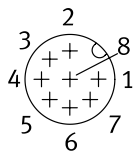

PIN	Function
1	Signal trace A
2	Signal trace A/
3	Signal trace B
4	Signal trace B/
5	0 V
6	Signal trace N
7	Signal trace N/
8	5 V

Data sheet

Torque M as a function of rotational speed n

EMMS-ST-28

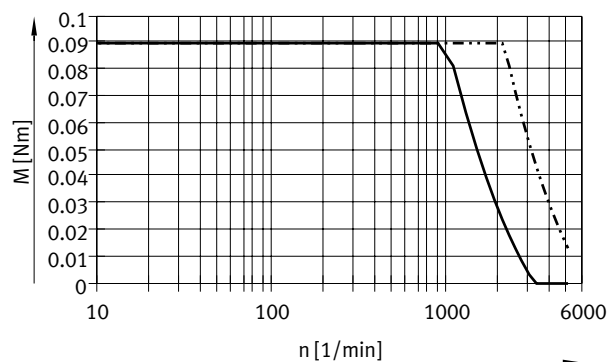

EMMS-ST-42

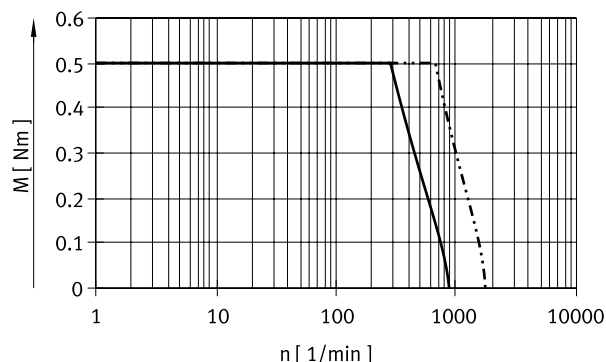

EMMS-ST-57-S

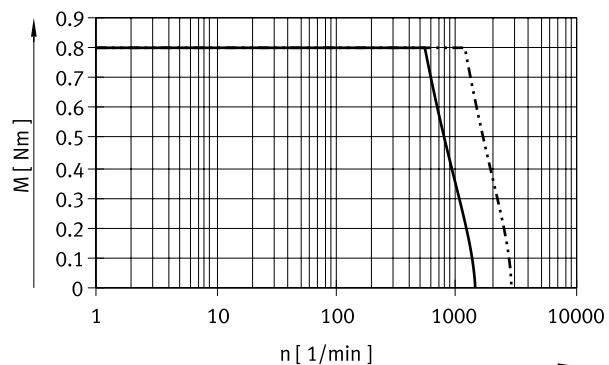

EMMS-ST-57-M

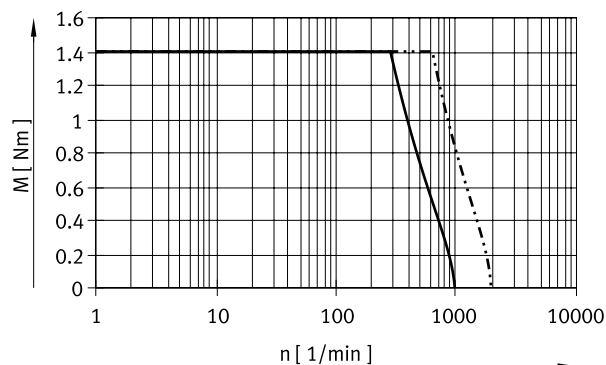

— 24 V DC
 - - - 48 V DC

Note
 Typical motor characteristic curves (typical production tolerances ±20%) with nominal voltage and optimal motor controller.

Data sheet

Torque M as a function of rotational speed n

EMMS-ST-87-S

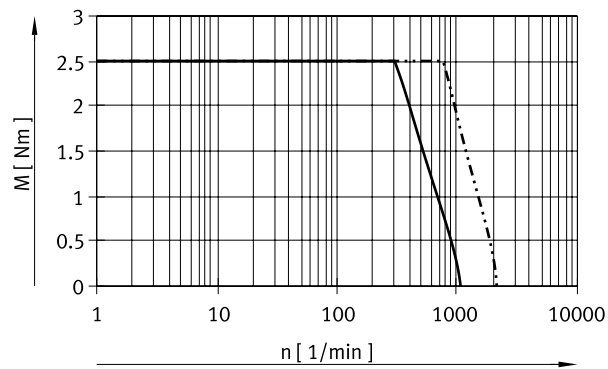

EMMS-ST-87-M

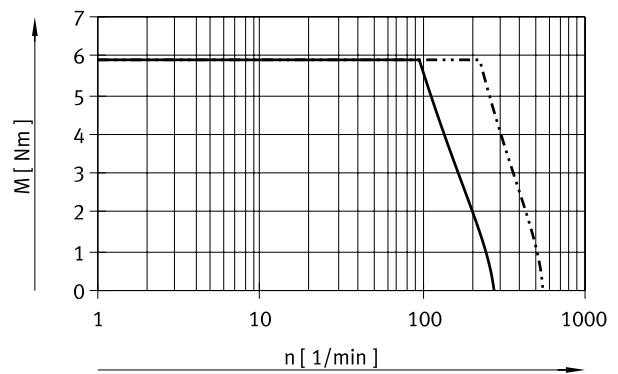

EMMS-ST-87-L

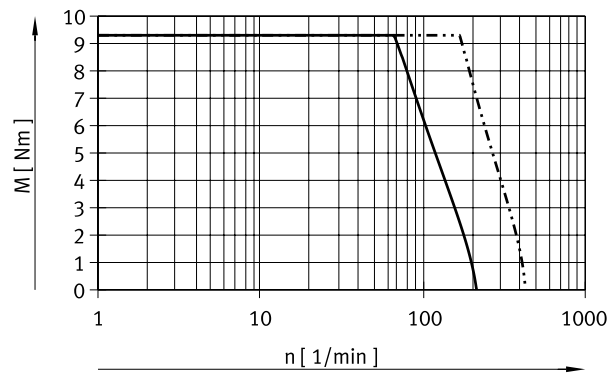

— 24 V DC
 - - - 48 V DC

Note
 Typical motor characteristic curves
 (typical production tolerances $\pm 20\%$)
 with nominal voltage and optimal
 motor controller.

Data sheet

Dimensions

Download CAD data → www.festo.com

Size 28

EMMS-ST...-S/SE

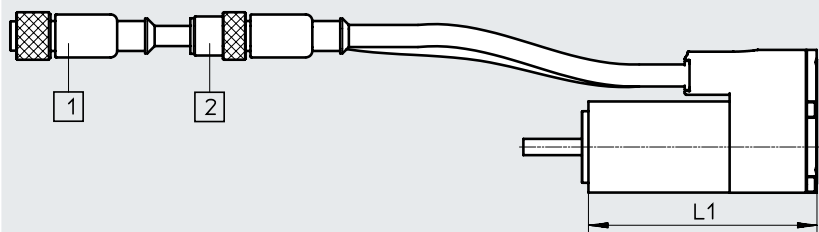

EMMS-ST...-SB/SEB

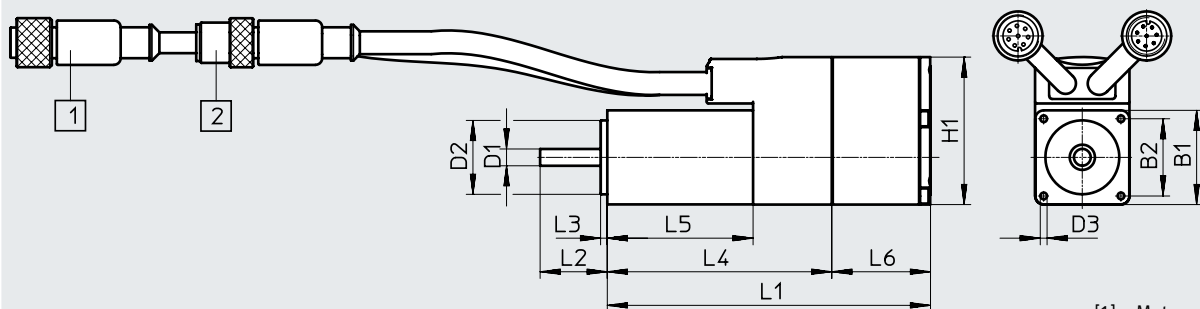

- [1] Motor cable
- [2] Encoder cable

Type	B1	B2	D1 ∅	D2 ∅	D3	H1
EMMS-ST-28-LS	28	23	5	22	M2.5x4.5	44
EMMS-ST-28-LSE						
EMMS-ST-28-LSB						
EMMS-ST-28-LSEB						

Type	L1	L2	L3	L4	L5	L6
EMMS-ST-28-LS	70±1	±1	2	67	43	-
EMMS-ST-28-LSE						±0.5
EMMS-ST-28-LSB	96±1.5	20	2	67	43	29
EMMS-ST-28-LSEB						

Data sheet

Dimensions

Download CAD data → www.festo.com

Size 42, 57, 87
EMMS-ST...S

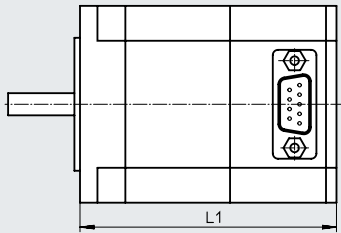

EMMS-ST...SB

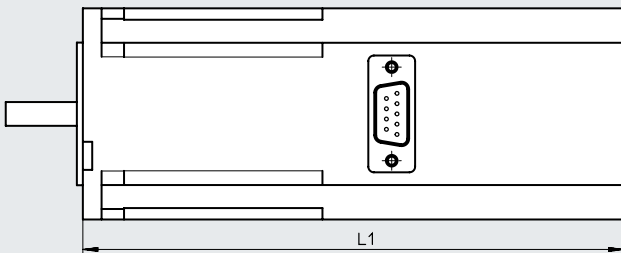

EMMS-ST...SE/SEB

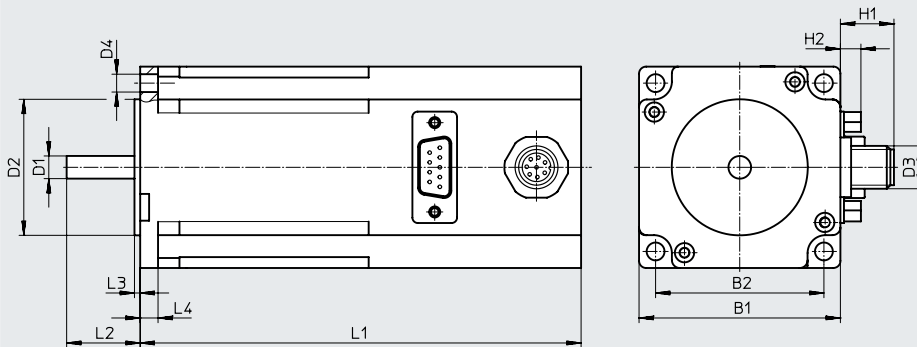

Plug pattern
9-pin Sub-D plug
for size 42, 57

15-pin Sub-D plug
for size 87

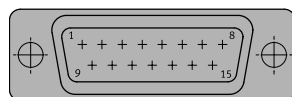
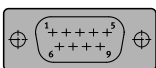

Data sheet

Type	B1	B2 ±0.2	D1 ∅	D2 ∅	D3	D4 ∅
EMMS-ST-42-S-S-G2	42.3	31	5-0.012	22-0.05	-	M3x4.5
EMMS-ST-42-S-SE-G2					M12	
EMMS-ST-42-S-SB-G2					-	
EMMS-ST-42-S-SEB-G2					M12	
EMMS-ST-57-S-S-G2	56.4	47.14	6.35-0.013	38.1±0.025	-	5
EMMS-ST-57-S-SE-G2					M12	
EMMS-ST-57-S-SB-G2					-	
EMMS-ST-57-S-SEB-G2					M12	
EMMS-ST-57-M-S-G2					-	
EMMS-ST-57-M-SE-G2					M12	
EMMS-ST-57-M-SB-G2	-					
EMMS-ST-57-M-SEB-G2	M12					
EMMS-ST-87-S-S-G2	85.85	69.5	11-0.013	73-0.046	-	6.6
EMMS-ST-87-S-SE-G2					M12	
EMMS-ST-87-S-SB-G2					-	
EMMS-ST-87-S-SEB-G2					M12	
EMMS-ST-87-M-S-G2					-	
EMMS-ST-87-M-SE-G2					M12	
EMMS-ST-87-M-SB-G2					-	
EMMS-ST-87-M-SEB-G2					M12	
EMMS-ST-87-L-S-G2					-	
EMMS-ST-87-L-SE-G2					M12	
EMMS-ST-87-L-SB-G2					-	
EMMS-ST-87-L-SEB-G2					M12	

Type	H1	H2	L1	L2	L3	L4
EMMS-ST-42-S-S-G2	-	6.5	66±1	24±1	2	-
EMMS-ST-42-S-SE-G2	13		94±1.2			
EMMS-ST-42-S-SB-G2	-		114±1.3			
EMMS-ST-42-S-SEB-G2	13		127±1.3			
EMMS-ST-57-S-S-G2	-	6.5	73.5±0.8	20.6±0.5	1.6	5
EMMS-ST-57-S-SE-G2	13		102.5±1.1			
EMMS-ST-57-S-SB-G2	-		123.5±1.1			
EMMS-ST-57-S-SEB-G2	13		138±1.1			
EMMS-ST-57-M-S-G2	-		95±0.8			
EMMS-ST-57-M-SE-G2	13		124±1.1			
EMMS-ST-57-M-SB-G2	-	145±1.1				
EMMS-ST-57-M-SEB-G2	13	159.5±1.1				
EMMS-ST-87-S-S-G2	-	6.5	82.6±1	27±1	2	8.38
EMMS-ST-87-S-SE-G2	13		112.6±1.3			
EMMS-ST-87-S-SB-G2	-		132.6±1.3			
EMMS-ST-87-S-SEB-G2	13		152.6±1.3			
EMMS-ST-87-M-S-G2	-		114.9±1			
EMMS-ST-87-M-SE-G2	13		144.9±1.3			
EMMS-ST-87-M-SB-G2	-		164.9±1.3			
EMMS-ST-87-M-SEB-G2	13		184.9±1.3			
EMMS-ST-87-L-S-G2	-		144.9±1			
EMMS-ST-87-L-SE-G2	13		174.9±1.3			
EMMS-ST-87-L-SB-G2	-		194.9±1.3			
EMMS-ST-87-L-SEB-G2	13		214.9±1.3			

Data sheet

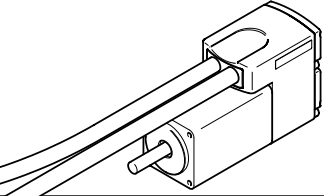
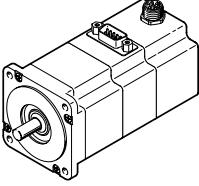
Ordering data	Size	Variant			Part no.	Type
		Basic type	With encoder	With brake		
	28	■			★ 1451384	EMMS-ST-28-L-S
			■		★ 1430663	EMMS-ST-28-L-SE
				■	★ 1451383	EMMS-ST-28-L-SB
			■	■	★ 1451382	EMMS-ST-28-L-SEB
	42	■			★ 1370470	EMMS-ST-42-S-S-G2
			■		★ 1370471	EMMS-ST-42-S-SE-G2
				■	★ 1370472	EMMS-ST-42-S-SB-G2
			■	■	★ 1370473	EMMS-ST-42-S-SEB-G2
	57	■			★ 1370474	EMMS-ST-57-S-S-G2
			■		★ 1370475	EMMS-ST-57-S-SE-G2
				■	★ 1370476	EMMS-ST-57-S-SB-G2
			■	■	★ 1370477	EMMS-ST-57-S-SEB-G2
		■			★ 1370478	EMMS-ST-57-M-S-G2
			■		★ 1370479	EMMS-ST-57-M-SE-G2
				■	★ 1370480	EMMS-ST-57-M-SB-G2
			■	■	★ 1370481	EMMS-ST-57-M-SEB-G2
	87	■			★ 1370482	EMMS-ST-87-S-S-G2
		■		★ 1370483	EMMS-ST-87-S-SE-G2	
			■	★ 1370484	EMMS-ST-87-S-SB-G2	
		■	■	★ 1370485	EMMS-ST-87-S-SEB-G2	
■				★ 1370486	EMMS-ST-87-M-S-G2	
		■		★ 1370487	EMMS-ST-87-M-SE-G2	
			■	★ 1370488	EMMS-ST-87-M-SB-G2	
		■	■	★ 1370489	EMMS-ST-87-M-SEB-G2	
■				★ 1370490	EMMS-ST-87-L-S-G2	
		■		★ 1370491	EMMS-ST-87-L-SE-G2	
			■	★ 1370493	EMMS-ST-87-L-SB-G2	
	■	■	★ 1370494	EMMS-ST-87-L-SEB-G2		

Festo core product range

- ★ Generally ready for dispatch from the factory within 24 hours
- ☆ Generally ready for dispatch from the factory within 5 days

Accessories

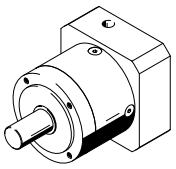
Ordering data – Gear unit		Data sheets → Internet: emga		
	For motor	Gear ratio	Part no.	Type
	EMMS-ST-42	3	☆ 549428	EMGA-40-P-G3-SST-42
		5	☆ 549429	EMGA-40-P-G5-SST-42
		8	8141762	EMGA-40-P-G8-SST-42
		12	8141763	EMGA-40-P-G12-SST-42
	EMMS-ST-57	3	☆ 549430	EMGA-60-P-G3-SST-57
		5	☆ 549431	EMGA-60-P-G5-SST-57
		8	8141764	EMGA-60-P-G8-SST-57
		12	8141765	EMGA-60-P-G12-SST-57
	EMMS-ST-87	3	☆ 549432	EMGA-80-P-G3-SST-87
		5	☆ 549433	EMGA-80-P-G5-SST-87
		8	8141766	EMGA-80-P-G8-SST-87
		12	8141767	EMGA-80-P-G12-SST-87

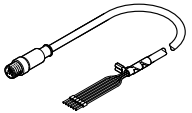
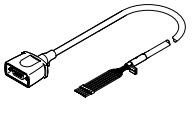
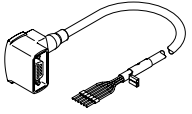
Ordering data				
	Description	Cable length [m]	Part no.	Type
Motor cable				
For EMMS-ST-28 and motor controller CMMT-ST				
	Straight plug • Min. bending radius: 62 mm • Suitable for energy chains • Ambient temperature: -40 ... +80°C	1.5	☆ 1449600	NEBM-SM12G8-E-1.5-Q5-LE6
		2.5	☆ 1449601	NEBM-SM12G8-E-2.5-Q5-LE6
		5.0	☆ 1449602	NEBM-SM12G8-E-5-Q5-LE6
		7.0	☆ 1449603	NEBM-SM12G8-E-7-Q5-LE6
		10.0	☆ 1449604	NEBM-SM12G8-E-10-Q5-LE6
		X length ¹⁾	1449605	NEBM-SM12G8-E-...-Q5-LE6
For EMMS-ST-4 2/57 and motor controller CMMT-ST/CMMS-ST				
	Straight plug • Min. bending radius: 62 mm • Suitable for energy chains • Ambient temperature: -40 ... +80°C	1.5	☆ 1450368	NEBM-S1G9-E-1.5-Q5-LE6
		2.5	☆ 1450369	NEBM-S1G9-E-2.5-Q5-LE6
		5.0	☆ 1450370	NEBM-S1G9-E-5-Q5-LE6
		7.0	☆ 1450371	NEBM-S1G9-E-7-Q5-LE6
		10.0	☆ 1450372	NEBM-S1G9-E-10-Q5-LE6
		X length ¹⁾	1450373	NEBM-S1G9-E-...-Q5-LE6
	Angled plug • Min. bending radius: 62 mm • Suitable for energy chains • Ambient temperature: -40 ... +80°C	1.5	☆ 1450736	NEBM-S1W9-E-1.5-Q5-LE6
		2.5	☆ 1450737	NEBM-S1W9-E-2.5-Q5-LE6
		5.0	☆ 1450738	NEBM-S1W9-E-5-Q5-LE6
		7.0	☆ 1450739	NEBM-S1W9-E-7-Q5-LE6
		10.0	☆ 1450740	NEBM-S1W9-E-10-Q5-LE6
		X length ¹⁾	1450741	NEBM-S1W9-E-...-Q5-LE6

1) Maximum 25 m. Available in 0.1 m increments.

Festo core product range

- ☆ Generally ready for dispatch from the factory within 24 hours
- ☆ Generally ready for dispatch from the factory within 5 days

Accessories

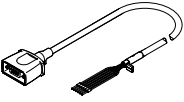
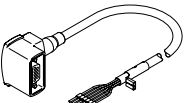
Ordering data	Description	Cable length [m]	Part no.	Type
Motor cable				
For EMMS-ST-87 and motor controller CMMT-ST/CMMS-ST				
	Straight plug • Min. bending radius: 80 mm • Suitable for energy chains • Ambient temperature: -40 ... +80°C	1.5	★ 1450834	NEBM-S1G15-E-1.5-Q7-LE6
		2.5	★ 1450835	NEBM-S1G15-E-2.5-Q7-LE6
		5.0	★ 1450836	NEBM-S1G15-E-5-Q7-LE6
		7.0	★ 1450837	NEBM-S1G15-E-7-Q7-LE6
		10.0	★ 1450838	NEBM-S1G15-E-10-Q7-LE6
		X length ¹⁾	1450839	NEBM-S1G15-E-...-Q7-LE6
	Angled plug • Min. bending radius: 80 mm • Suitable for energy chains • Ambient temperature: -40 ... +80°C	1.5	★ 1450943	NEBM-S1W15-E-1.5-Q7-LE6
		2.5	★ 1450944	NEBM-S1W15-E-2.5-Q7-LE6
		5.0	★ 1450945	NEBM-S1W15-E-5-Q7-LE6
		7.0	★ 1450946	NEBM-S1W15-E-7-Q7-LE6
		10.0	★ 1450947	NEBM-S1W15-E-10-Q7-LE6
		X length ¹⁾	1450948	NEBM-S1W15-E-...-Q7-LE6

1) Maximum 25 m. Available in 0.1 m increments.

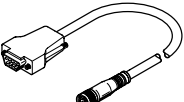
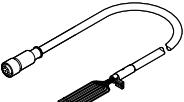
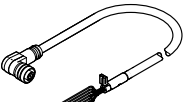
Ordering data	Description	Cable length [m]	Part no.	Type
Encoder cable				
For motor controller CMMS-ST				
	Straight plug • Min. bending radius: 51 mm • Suitable for energy chains • Ambient temp.: -40 ... +70°C	5.0	★ 550748	NEBM-M12G8-E-5-S1G9
		10.0	★ 550749	NEBM-M12G8-E-10-S1G9
		15.0	★ 550750	NEBM-M12G8-E-15-S1G9
		X length ¹⁾	550751	NEBM-M12G8-E-...-S1G9
		For motor controller CMMT-ST		
	Straight plug • Min. bending radius: 68 mm • Suitable for energy chains • Ambient temperature: -40 ... +80°C	1.5	★ 1451586	NEBM-M12G8-E-1.5-LE8
		2.5	★ 1451587	NEBM-M12G8-E-2.5-LE8
		5.0	★ 1451588	NEBM-M12G8-E-5-LE8
		7.0	★ 1451589	NEBM-M12G8-E-7-LE8
		10.0	★ 1451590	NEBM-M12G8-E-10-LE8
		X length ¹⁾	1451591	NEBM-M12G8-E-...-LE8
	Angled plug • Min. bending radius: 68 mm • Suitable for energy chains • Ambient temperature: -40 ... +80°C	1.5	★ 1451674	NEBM-M12W8-E-1.5-LE8
		2.5	★ 1451675	NEBM-M12W8-E-2.5-LE8
		5.0	★ 1451676	NEBM-M12W8-E-5-LE8
		7.0	★ 1451677	NEBM-M12W8-E-7-LE8
		10.0	★ 1451678	NEBM-M12W8-E-10-LE8
		X length ¹⁾	1451679	NEBM-M12W8-E-...-LE8

1) Maximum 25 m. Available in 0.1 m increments.

Note

Angled cables and leads can protrude into the area of the axis/drive!

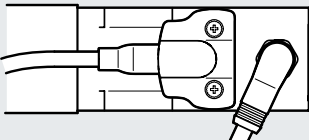

Festo core product range

- ★ Generally ready for dispatch from the factory within 24 hours
- ★ Generally ready for dispatch from the factory within 5 days